

**BMR458 series** Fully regulated DC/DC Converters  
 Input 36-75 V, Output up to 50 A / 600 W

1/28701-BMR458 0032 revA July 2018

© Flex

### Key Features

- Industry standard Quarter-Brick with digital PMBus interface  
 58.4 x 36.8 x 13.2 mm (2.30 x 1.455 x 0.519 in)
- High efficiency, typ. 96.4% at half load, 12 Vout
- 2250 Vdc input to output functional isolation
- Baseplate option available
- Meets safety requirements according to IEC/EN/UL 60950-1
- PMBus Revision 1.3 compliant
- 8.8 million hours MTBF
- ISO 9001/14001 certified supplier

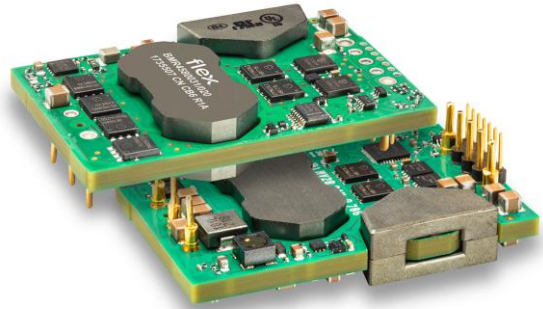

### Power Management

- Configurable soft start/stop
- Precision delay and ramp-up
- Voltage margining
- Voltage/current/temperature monitoring
- Adjustable output voltage
- Power good



### Safety Approvals



### Design for Environment



Meets requirements in high-temperature lead-free soldering processes.

### Contents

Ordering Information	2
General Information	2
Safety Specification	4
Absolute Maximum Ratings	5
Electrical Specification	
12 V, 50 A / 600 W	BMR 4580032/003..... 9
12.45 V, 50 A / 600 W(Droop Load Share)	BMR 4580032/014..... 13
EMC Specification	16
Power Management Overview	17
Operating Information	19
Thermal Consideration	24
Connections	25
Mechanical Information	27
Soldering Information	28
Delivery Information	29
Product Qualification Specification	31
Appendix – PMBus Commands	32

### BMR458 series Fully regulated DC/DC Converters Input 36-75 V, Output up to 50 A / 600 W

1/28701-BMR458 0032 revA July 2018

© Flex

#### Ordering Information

Product program	Vin	Output
BMR4580032/003	36 - 75	12 V / 50 A, 600 W
BMR4580032/014	36 - 75	12.45 V / 50 A, 600 W

#### Product number and Packaging

BMR458	n <sub>1</sub>	n <sub>2</sub>	n <sub>3</sub>	n <sub>4</sub>	/	n <sub>5</sub>	n <sub>6</sub>	n <sub>7</sub>	n <sub>8</sub>
Mechanical pin option	x				/				
Mechanical option		x			/				
Hardware option			x	x	/				
Configuration file					/	x	x	x	
Packaging(optional)					/				x

#### Options Description

n <sub>1</sub>	0 = Standard pin length 5.33 mm(0.210 in.) 2 = Lead length 3.69 mm(0.145 in.) (cut) 3 = Lead length 4.57 mm(0.180 in.) (cut) 4 = Lead length 2.79 mm(0.110 in.) (cut)
n <sub>2</sub>	0 = Open frame 1 = Baseplate 2 = Baseplate with GND-pin
n <sub>3</sub> n <sub>4</sub>	32 = 36-75 Vin, 8-13.2 Vout adjustable, with digital interface.
n <sub>5</sub> n <sub>6</sub> n <sub>7</sub>	003 = 12 V standard configuration for 36-75 Vin 014 = 12.45 V with 0.5V droop load sharing function, latching OCP configuration for 36-75 Vin  xxx = Application Specific Configuration
n <sub>8</sub>	Blank = 20 converters(through hole pin)/tray, 3 trays/ box, PE foam dissipative E = Through hole pin-in-paste product with dry package, 12 converters(through hole pin)/tray, 4 trays/ box, Antistatic Polystyrene

Example: Product number BMR4582132/003 equals an through hole mount lead length 3.69 mm (cut), baseplate, digital interface with 12 V standard configuration variant.

Product number BMR4583132/003E equals a through hole mount lead length 4.57 mm (cut), baseplate, digital interface with 12 V configuration variant with Antistatic Polystyrene dry package.

For application specific configurations contact your local Flex Power Modules sales representative.

#### General Information

##### Reliability

The failure rate ( $\lambda$ ) and mean time between failures (MTBF=  $1/\lambda$ ) is calculated at max output power and an operating ambient temperature ( $T_A$ ) of +40°C. Flex Power Modules uses Telcordia SR-332 Issue 3 Method 1 to calculate the mean steady-state failure rate and standard deviation ( $\sigma$ ).

Telcordia SR-332 Issue 4 also provides techniques to estimate the upper confidence levels of failure rates based on the mean and standard deviation.

Mean steady-state	Std. deviation, $\sigma$
123 nFailures/h	8.0 nFailures/h

MTBF (mean value) for the BMR458 series = 8.8 Mh.  
MTBF at 90% confidence level = 8.1 Mh

##### Compatibility with RoHS requirements

The products are compatible with the relevant clauses and requirements of the RoHS directive 2011/65/EU and have a maximum concentration value of 0.1% by weight in homogeneous materials for lead, mercury, hexavalent chromium, PBB and PBDE and of 0.01% by weight in homogeneous materials for cadmium.

Exemptions in the RoHS directive utilized in Flex Power Modules products are found in the Statement of Compliance document.

Flex Power Modules fulfills and will continuously fulfill all its obligations under regulation (EC) No 1907/2006 concerning the registration, evaluation, authorization and restriction of chemicals (REACH) as they enter into force and is through product materials declarations preparing for the obligations to communicate information on substances in the products.

##### Quality Statement

The products are designed and manufactured in an industrial environment where quality systems and methods like ISO 9000, Six Sigma, and SPC are intensively in use to boost the continuous improvements strategy. Infant mortality or early failures in the products are screened out and they are subjected to an ATE-based final test. Conservative design rules, design reviews and product qualifications, plus the high competence of an engaged work force, contribute to the high quality of the products.



<b>BMR458 series</b> Fully regulated DC/DC Converters Input 36-75 V, Output up to 50 A / 600 W	1/28701-BMR458 0032 revA	July 2018
	© Flex	

### Warranty

Warranty period and conditions are defined in Flex Power Modules General Terms and Conditions of Sale.

### Limitation of Liability

Flex Power Modules does not make any other warranties, expressed or implied including any warranty of merchantability or fitness for a particular purpose (including, but not limited to, use in life support applications, where malfunctions of product can cause injury to a person's health or life).

### © Flex 2018

The information and specifications in this technical specification is believed to be correct at the time of publication. However, no liability is accepted for inaccuracies, printing errors or for any consequences thereof. Flex reserves the right to change the contents of this technical specification at any time without prior notice.

**BMR458 series** Fully regulated DC/DC Converters  
Input 36-75 V, Output up to 50 A / 600 W

1/28701-BMR458 0032 revA

July 2018

© Flex

## Safety Specification

### General information

Flex Power Modules DC/DC converters and DC/DC regulators are designed in accordance with the safety standards IEC 60950-1, EN 60950-1 and UL 60950-1 *Safety of Information Technology Equipment*.

IEC/EN/UL 60950-1 contains requirements to prevent injury or damage due to the following hazards:

- Electrical shock
- Energy hazards
- Fire
- Mechanical and heat hazards
- Radiation hazards
- Chemical hazards

On-board DC/DC converters and DC/DC regulators are defined as component power supplies. As components they cannot fully comply with the provisions of any safety requirements without “conditions of acceptability”. Clearance between conductors and between conductive parts of the component power supply and conductors on the board in the final product must meet the applicable safety requirements. Certain conditions of acceptability apply for component power supplies with limited stand-off (see Mechanical Information and Safety Certificate for further information). It is the responsibility of the installer to ensure that the final product housing these components complies with the requirements of all applicable safety standards and regulations for the final product.

Component power supplies for general use should comply with the requirements in IEC/EN/UL 60950-1 *Safety of Information Technology Equipment*. Product related standards, e.g. IEEE 802.3af *Power over Ethernet*, and ETS-300132-2 *Power interface at the input to telecom equipment, operated by direct current (dc)* are based on IEC/EN/UL 60950-1 with regards to safety.

Flex Power Modules DC/DC converters, Power interface modules and DC/DC regulators are UL 60950-1 recognized and certified in accordance with EN 60950-1. The flammability rating for all construction parts of the products meet requirements for V-0 class material according to IEC 60695-11-10, *Fire hazard testing, test flames – 50 W* horizontal and vertical flame test methods.

### BMR458

BMR458 provides functional insulation between input and output according to IEC/EN/UL 60950-1.

The output is considered as safety extra low voltage (SELV) if one of the following conditions is met:

- The input source provides double or reinforced insulation from the AC mains according to IEC/EN/UL 60950-1.
- The input source provides basic or supplementary insulation from the AC mains and the product’s output is reliably connected to protective earth according to IEC/EN/UL 60950-1.
- The input source is reliably connected to protective earth and provides basic or supplementary insulation according to IEC/EN/UL 60950-1 and the maximum input source voltage is 60 Vdc.

Galvanic isolation between input and output is verified in an electric strength test and the isolation voltage ( $V_{iso}$ ) meets the voltage strength requirement for basic insulation according to IEC/EN/UL 60950-1.

It is recommended to use a slow blow fuse at the input of each DC/DC converter. If an input filter is used in the circuit the fuse should be placed in front of the input filter. In the rare event of a component problem that imposes a short circuit on the input source, this fuse will provide the following functions:

- Isolate the fault from the input power source so as not to affect the operation of other parts of the system
- Protect the distribution wiring from excessive current and power loss thus preventing hazardous overheating

**BMR458 series** Fully regulated DC/DC Converters  
 Input 36-75 V, Output up to 50 A / 600 W

1/28701-BMR458 0032 revA July 2018  
 © Flex

**Absolute Maximum Ratings**

Characteristics		min	typ	max	Unit
T <sub>P1</sub>	Operating Temperature (see Thermal Consideration section)	-40		+125	°C
T <sub>S</sub>	Storage temperature	-55		+125	°C
V <sub>I</sub>	Input voltage	-0.5		+80	V
C <sub>out</sub>	Output capacitance	100			µF
V <sub>iso</sub>	Isolation voltage (input to output)			2250	Vdc
V <sub>iso</sub>	Isolation voltage (input to baseplate)			1500	Vdc
V <sub>iso</sub>	Isolation voltage (baseplate to output)			750	Vdc
V <sub>tr</sub>	Input voltage transient			100	V
V <sub>RC</sub>	Remote Control pin voltage (see Operating Information section)	Positive logic option		5	V
		Negative logic option	-0.5	5	V

Stresses above those listed under Absolute Maximum Ratings may cause permanent damage to the device. This is a stress rating only; functional operation of the device at these or any other conditions above those indicated in the Electrical Specification section of this specification is not implied. Exposure to absolute maximum rating conditions for extended periods may affect device reliability.

**Configuration File**

This product is designed with a digital control circuit. The control circuit uses a configuration file which determines the functionality and performance of the product. The Electrical Specification table shows parameter values of functionality and performance with the Standard configuration, unless otherwise specified. The Standard configuration is designed to fit most application needs. Changes in Standard configuration can be done to optimize performance in specific application.

**Fundamental Circuit Diagram**

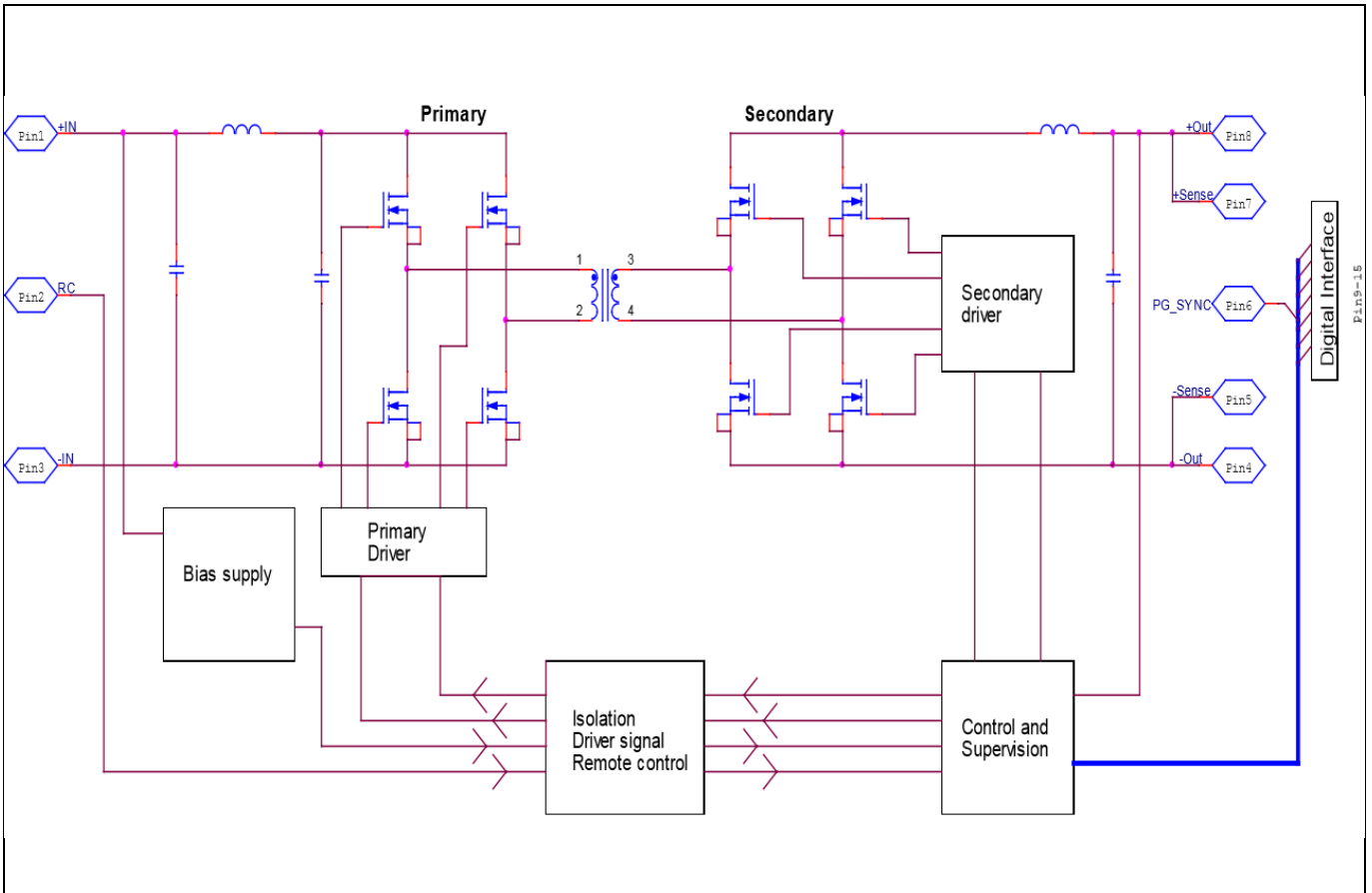

<b>BMR458 series Fully regulated DC/DC Converters</b> Input 36-75 V, Output up to 50 A / 600 W	1/28701-BMR458 0032 revA July 2018
	© Flex

**Common Electrical Specification**

This section includes parameter specifications common to all product versions within the product series. Typically these are parameters defined by the digital controller of the products. In the table below PMBus commands for configurable parameters are written in capital letters.

$T_{P1}$  = -30 to +95 °C,  $V_I$  = 36 to 75 V, unless otherwise specified under Conditions.  
 Typical values given at:  $T_{P1}$  = +25 °C,  $V_I$  = 53 V, max  $I_O$ , unless otherwise specified under Conditions:  
 BMR458XXX/003 (Stand alone)

Characteristics		Conditions	min	typ	max	Unit
$f_{SW} = 1/T_{SW}$	Switching Frequency			180		kHz
	Switching Frequency Range, Note 1	PMBus configurable FREQUENCY_SWITCH	160		200	kHz
	Switching Frequency Set-point Accuracy	$T_{P1} = +25\text{ °C}$	-1		1	%
	External Sync Pulse Width		150			ns
	Input Clock Frequency Drift Tolerance	External sync	-4		4	%

$T_{INIT}$	Initialization Time	From $V_I > \sim 27\text{ V}$ to ready to be enabled		30		ms
$T_{ONdel\_tot}$	Output voltage Total On Delay Time	Enable by input voltage		$T_{INIT} + T_{ONdel}$		
		Enable by RC or CTRL pin		$T_{ONdel}$		
$T_{ONdel}$	Output voltage On Delay Time	PMBus configurable Turn on delay duration		0		ms
		Range TON_DELAY	0		655	ms
		Accuracy (actual delay vs set value)		$\pm 1$		%
$T_{OFFdel}$	Output voltage Off Delay Time	PMBus configurable Turn off delay duration, Note 2		5		ms
		Range TOFF_DELAY	0		655	ms
		Accuracy (actual delay vs set value), Note 3		$\pm 1$		%
$T_{ONrise} / T_{OFFfall}$	Output voltage On/Off Ramp Time (0-100%-0 of $V_O$ )	Turn on ramp duration -Stand alone -DLS		10 200		ms
		Turn off ramp duration	Disabled in standard configuration. Turn off immediately upon expiration of Turn off delay.			ms
		Range TON_RISE/TOFF_FALL	0		655	ms
		Ramp time accuracy for standalone operation (actual ramp time vs set value)		$\pm 1$		%
$V_{loff}$	Input turn off range	States the level where the output voltage is disabled, PMBus configurable	30	33	75	V
$V_{lon}$	Input turn on range	States the level where the output voltage is enabled, PMBus configurable.	30	35	75	V

**BMR458 series Fully regulated DC/DC Converters**  
Input 36-75 V, Output up to 50 A / 600 W

1/28701-BMR458 0032 revA July 2018

© Flex

Characteristics		Conditions	min	typ	max	Unit
Power Good , PG	PG threshold	PMBus configurable Rising		8		V <sub>O</sub>
		PMBus configurable Falling		5		V <sub>O</sub>
	PG thresholds range	POWER_GOOD_ON VOUT_UV_FAULT_LIMIT	0		100	% V <sub>O</sub>
	PG delay	From V <sub>O</sub> reaching target to PG assertion		1		ms
Input Under Voltage Protection, IUVP	IUVP threshold	PMBus configurable		0		V
	IUVP threshold range	VIN_UV_FAULT_LIMIT		0-100		%V <sub>IN</sub>
	IUVP hysteresis	PMBus configurable		0		V
	IUVP hysteresis range	VIN_UV_FAULT_LIMIT- VIN_UV_WARN_LIMIT		0		V
	Set point accuracy			1		%
	IUVP response delay			100		µs
Input Over Voltage Protection, IOVP	IOVP threshold	PMBus configurable		85		V
		VIN_OV_FAULT_LIMIT		0-100		%V <sub>IN</sub>
	IOVP hysteresis	PMBus configurable VIN_OV_FAULT_LIMIT- VIN_OV_WARN_LIMIT		5		V
	IOVP hysteresis range	VIN_OV_WARN_LIMIT		0-100		%V <sub>IN</sub>
	Set point accuracy			±1		%
	IOVP response delay			100		µs
Output Voltage Over/Under Voltage Protection, OVP/UVP	UVP threshold	PMBus configurable		0		V <sub>O</sub>
		VOUT_UV_FAULT_LIMIT		0-100		%V <sub>O</sub>
	OVP threshold	PMBus configurable		15.6		V <sub>O</sub>
	OVP threshold range	VOUT_OV_FAULT_LIMIT		0-16		V <sub>O</sub>
	UVP/OVP response time			100/50		µs
	Fault response	PMBus configurable VOUT_UV_FAULT_RESPONSE		Ignore fault		
PMBus configurable VOUT_OV_FAULT_RESPONSE			Disable until fault cleared			
Over Current Protection, OCP Note 5	OCP threshold	PMBus configurable		58		A
	OCP threshold range	IOUT_OC_FAULT_LIMIT		0-120		A
	Protection delay	See Note 4		0		ms
	Fault response	PMBus configurable MFR_IOUT_OC_FAULT_RESPONSE -Stand alone, see Note 6 -DLS		Shutdown, automatic restart 2 ms delay then shut down, no retry		
Over Temperature Protection, OTP, Note 7	OTP threshold	PMBus configurable		125		°C
	OTP threshold range	OT_FAULT_LIMIT	-50		+150	°C
	OTP hysteresis	PMBus configurable OT_FAULT_LIMIT- OT_WARN_LIMIT		35		°C
	Fault response	PMBus configurable OT_FAULT_RESPONSE		Shutdown, automatic restart when no fault exist, -90°C @ the temperature sensor		

**BMR458 series Fully regulated DC/DC Converters**  
 Input 36-75 V, Output up to 50 A / 600 W

1/28701-BMR458 0032 revA July 2018

© Flex

Characteristics		Conditions	min	typ	max	Unit
Monitoring Accuracy	Input voltage READ_VIN			±125		mV
	Output voltage READ_VOUT			±10		mV
	Output current READ_IOUT	$T_{P1} = 25\text{ °C}, V_O = 12.0\text{ V}$		±0.25		A
		$T_{P1} = -30 - 125\text{ °C}, V_O = 12.0\text{ V}$		±1		A
	Duty cycle READ_DUTY_CYCLE		No tolerance, Read value is the actual value applied by PWM controller			
Temperature READ_TEMPERATURE_1	Temperature sensor, -30 - 125 °C		±5		°C	

Current difference between products in a current sharing group	Steady state operation	Max 2 x READ_IOUT monitoring accuracy	
Supported number of products in a current sharing group			6

$V_{OL}$	Logic output low signal level			0.25	V
$V_{OH}$	Logic output high signal level	SCL, SDA, SYNC, GCB, SALERT, PG Sink/source current = 4 mA	2.7		V
$I_{OL}$	Logic output low sink current			4	mA
$I_{OH}$	Logic output high source current			4	mA
$V_{IL}$	Logic input low threshold			1.1	V
$V_{IH}$	Logic input high threshold	SCL, SDA, CTRL, SYNC	2.1		V
$C_{L\_PIN}$	Logic pin input capacitance	SCL, SDA, CTRL, SYNC		10	pF
$R_{CS\_PU}$	Secondary Remote Control logic pin internal pull-up resistance	SCL, SDA, SALERT	No internal pull-up		
		CTRL to +3.3V Note 8		47	kΩ
$f_{SMB}$	Supported SMBus Operating frequency		100		400 kHz
$T_{BUF}$	SMBus Bus free time	STOP bit to START bit See section SMBus – Timing		1.3	μs
$t_{set}$	SMBus SDA setup time from SCL	See section SMBus – Timing		100	ns
$t_{hold}$	SMBus SDA hold time from SCL	See section SMBus – Timing		0	ns
	SMBus START/STOP condition setup/hold time from SCL			600	ns
$T_{low}$	SCL low period		1.3		μs
$T_{high}$	SCL high period			0.6	50 μs

Note 1. There are configuration changes to consider when changing the switching frequency, see section Switching Frequency.

Note 2. A default value of 0 ms forces the device to Immediate Off behavior with TOFF\_FALL ramp-down setting being ignored.

Note 3. The specified accuracy applies for off delay times larger than 4 ms. When setting 0 ms the actual delay will be 0 ms.

Note 4. According to the combination of command MFR\_RESPONSE\_UNIT\_CFG and delay time set in IOUT\_OC\_FAULT\_RESPONSE, see Appendix – PMBus commands.

Note 5. higher OCP threshold than specified may result in damage of the module at OC fault conditions.

Note 6. For current setting see Appendix – PMBus commands

Note 7. See section Over Temperature Protection (OTP).

Note 8. If configure the CTRL pin with internal Pull-up with command MFR\_MULTI\_PIN\_CONFIG, see Appendix – PMBus commands.



**BMR458 series Fully regulated DC/DC Converters**  
Input 36-75 V, Output up to 50 A / 600 W

1/28701-BMR458 0032 revA July 2018  
© Flex

**Electrical Specification**  
**12 V, 50 A / 600 W**

**BMR 458 0032/003**

$T_{P1} = -30$  to  $+95^{\circ}\text{C}$ ,  $V_I = 36$  to  $75$  V, sense pins connected to output pins unless otherwise specified under Conditions.  
Typical values given at:  $T_{P1} = +25^{\circ}\text{C}$ ,  $V_I = 53$  V,  $I_O$  max, unless otherwise specified under Conditions.  
Additional  $C_{in} = 220 \mu\text{F}$ ,  $C_{out} = 100 \mu\text{F}$ . See Operating Information section for selection of capacitor types.

Characteristics		Conditions	min	typ	max	Unit
$V_I$	Input voltage range		36		75	V
$V_{loff}$	Turn-off input voltage,	Decreasing input voltage	31	33	35	V
$V_{lon}$	Turn-on input voltage	Increasing input voltage	33	35	37	V
$C_I$	Internal input capacitance			15		$\mu\text{F}$
$P_O$	Output power		0		600	W
$\eta$	Efficiency	50% of max $I_O$		96.2		%
		max $I_O$		95.8		
		50% of max $I_O$ , $V_I = 48$ V		96.4		
		max $I_O$ , $V_I = 48$ V		95.8		
$P_d$	Power Dissipation	max $I_O$		26	37	W
$P_{li}$	Input idling power	$I_O = 0$ A, $V_I = 53$ V		4.8		W
$P_{RC}$	Input standby power	$V_I = 53$ V (turned off with RC)		0.85		W
$f_s$	Switching frequency	0-100 % of max $I_O$ see Note 1	174	180	186	kHz

$V_{Oi}$	Output voltage initial setting and accuracy	$T_{P1} = +25^{\circ}\text{C}$ , $V_I = 53$ V, $I_O = 50$ A	12.00	12.01	12.02	V
$V_O$	Output adjust range	See operating information	8		13.2	V
	Output voltage tolerance band	0-100% of max $I_O$	11.76		12.24	V
	Idling voltage	$I_O = 0$ A	11.9		12.1	V
	Line regulation	max $I_O$		5	20	mV
	Load regulation	$V_I = 53$ V, 0-100% of max $I_O$		10	32	mV
$V_{tr}$	Load transient voltage deviation	$V_I = 53$ V, Load step 25-75-25% of max $I_O$ , $di/dt = 5$ A/ $\mu\text{s}$ , $C_{out} = 5$ mF		$\pm 350$	$\pm 530$	mV
$t_{tr}$	Load transient recovery time				0.7	ms
$t_r$	Ramp-up time (from 0-100% of $V_{Oi}$ )	0-100% of max $I_O$		10		ms
$t_s$	Start-up time (from $V_I$ connection to 100% of $V_{Oi}$ )			40		ms
$t_{RC}$	RC start-up time (from $V_{RC}$ connection to 100% of $V_{Oi}$ )	max $I_O$		10.7		ms
RC	Sink current	See operating information	0.5			mA
	Trigger level			1.2		V
	Response time		0.4		1.1	ms
$I_O$	Output current		0		50	A
$I_{lim}$	Current limit threshold	$T_{P1} < \text{max } T_{P1}$	54	58	64	A
$I_{sc}$	Short circuit current	$T_{P1} = 25^{\circ}\text{C}$ , see Note 2		7.1		A
$C_{out}$	Recommended Capacitive Load	$T_{P1} = 25^{\circ}\text{C}$ , see Note 3	100		15000	$\mu\text{F}$
$V_{Oac}$	Output ripple & noise	See ripple & noise section, $V_{Oi}$		130	250	mVp-p
OVP	Over voltage protection	$T_{P1} = +25^{\circ}\text{C}$ , $V_I = 53$ V, 0-100% of max $I_O$		15.6		V

Note 1: For higher values, contact FAE.

Note 2: Typical RMS current when BMR458 OCP is operating in hiccup mode.

**BMR458 series** Fully regulated DC/DC Converters  
 Input 36-75 V, Output up to 50 A / 600 W

1/28701-BMR458 0032 revA July 2018

© Flex

**Typical Characteristics**  
**12 V, 50 A / 600 W**

**BMR 458 0032/003**

**Efficiency**

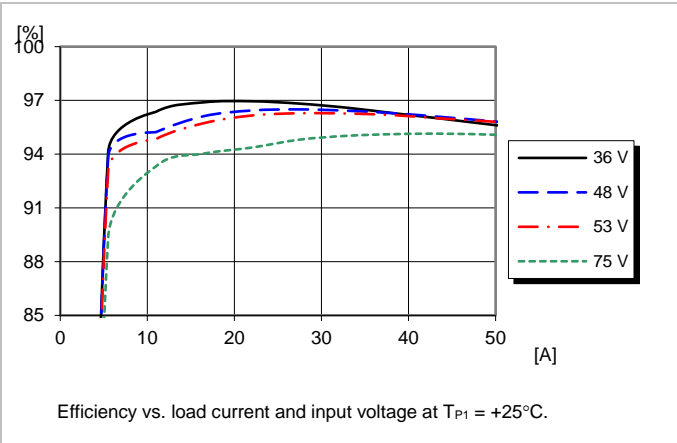

**Power Dissipation**

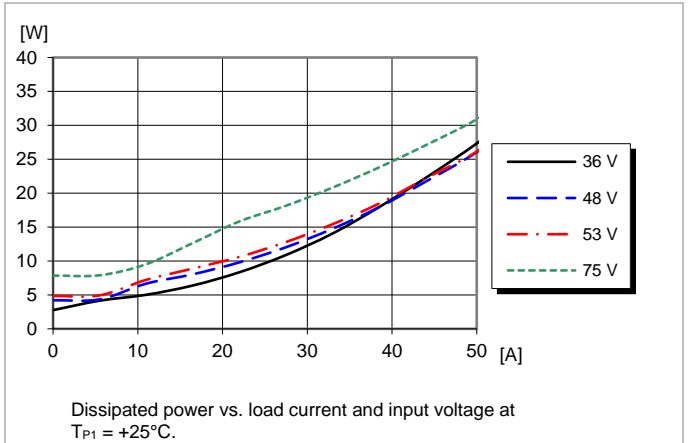

**Output Characteristics**

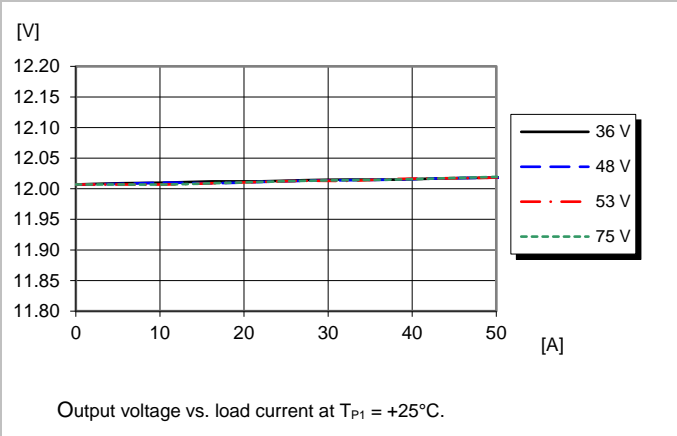

**Output Characteristics**

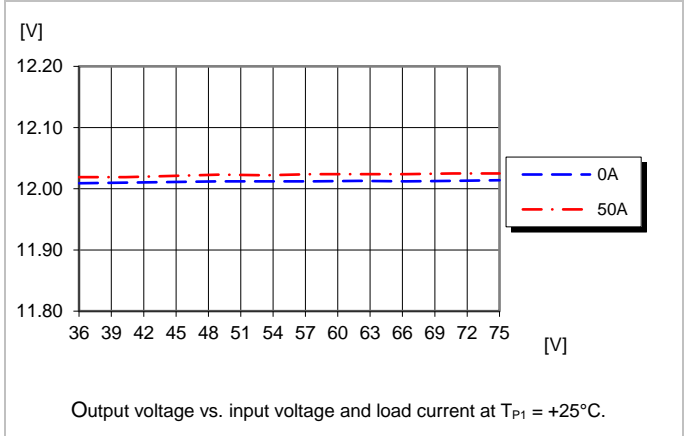

**Current Limit Characteristics**

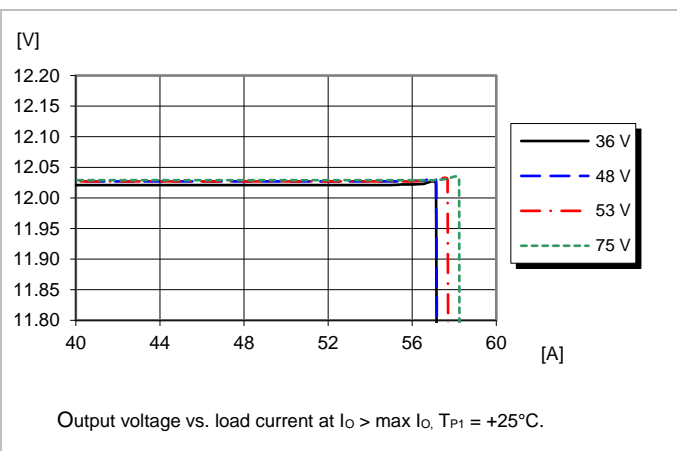

**Available Power**

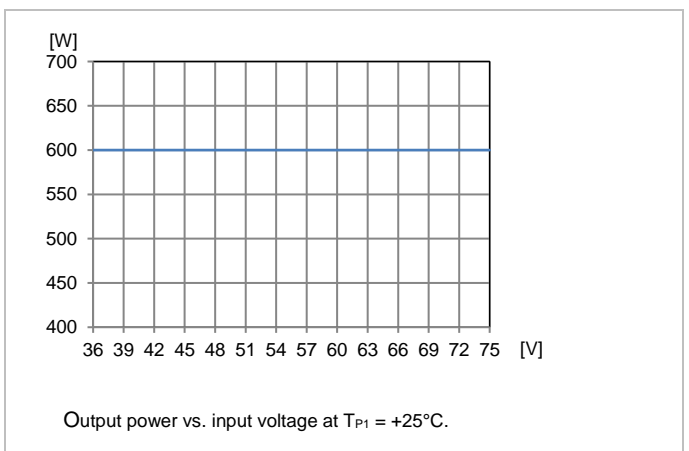

**BMR458 series** Fully regulated DC/DC Converters  
 Input 36-75 V, Output up to 50 A / 600 W

1/28701-BMR458 0032 revA July 2018

© Flex

### Typical Characteristics 12 V, 50 A / 600 W

**BMR 458 0032/003**

#### Start-up

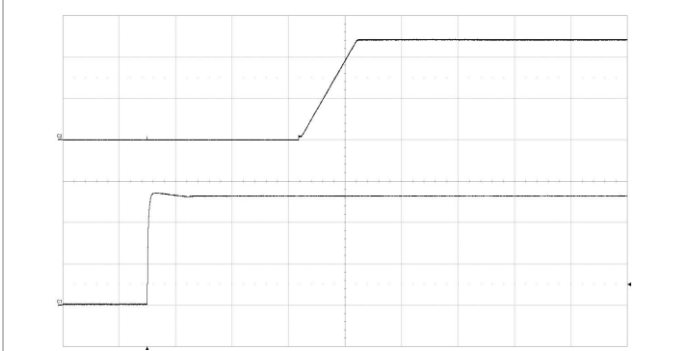

Start-up enabled by connecting  $V_1$  at:  
 $T_{P1} = +25^\circ\text{C}$ ,  $V_1 = 53\text{ V}$ ,  
 $I_o = 50\text{ A}$  resistive load.

Top trace: output voltage (5 V/div.).  
 Bottom trace: input voltage (20 V/div.).  
 Time scale: (10 ms/div.).

#### Shut-down

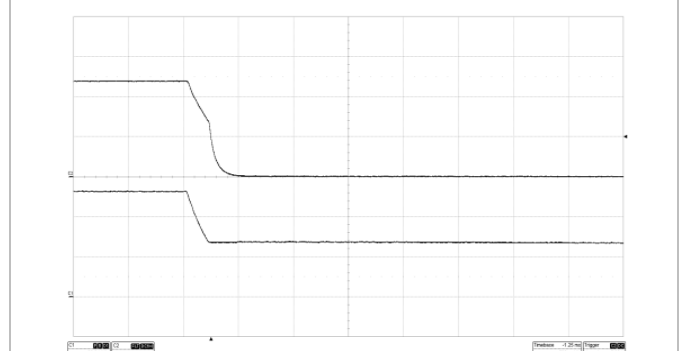

Shut-down enabled by disconnecting  $V_1$  at:  
 $T_{P1} = +25^\circ\text{C}$ ,  $V_1 = 53\text{ V}$ ,  
 $I_o = 50\text{ A}$  resistive load.

Top trace: output voltage (5 V/div.).  
 Bottom trace: input voltage (20 V/div.).  
 Time scale: (0.5 ms/div.).

#### Output Ripple & Noise

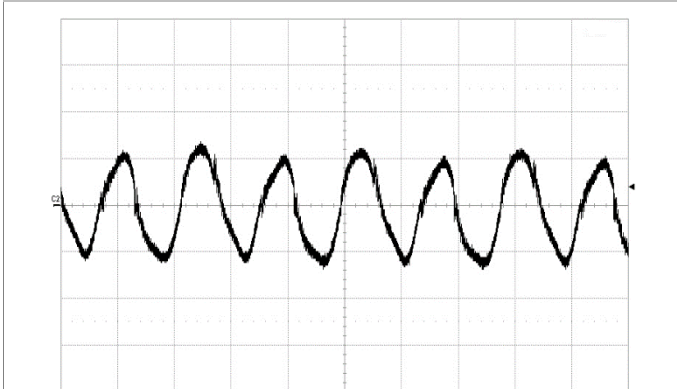

Output voltage ripple at:  
 $T_{P1} = +25^\circ\text{C}$ ,  $V_1 = 53\text{ V}$ ,  
 $I_o = 50\text{ A}$  resistive load.

Trace: output voltage (50 mV/div.).  
 Time scale: (2  $\mu\text{s}$ /div.).

#### Output Load Transient Response

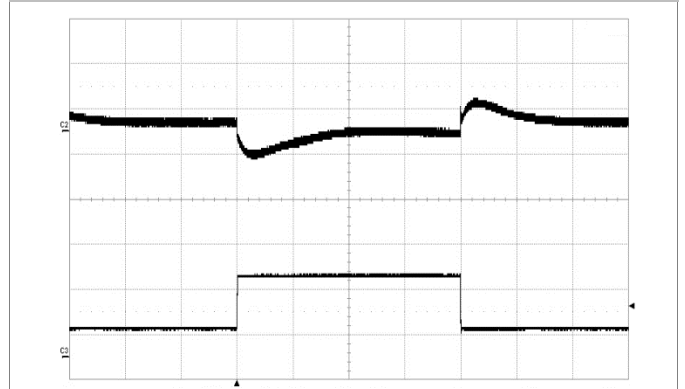

Output voltage response to load current step-  
 change (12.5-37.5-12.5 A) at:  
 $T_{P1} = +25^\circ\text{C}$ ,  $V_1 = 53\text{ V}$ .

Top trace: output voltage (500 mV/div.).  
 Bottom trace: load current (20 A/div.).  
 Time scale: (0.5 ms/div.).

#### Input Voltage Transient Response

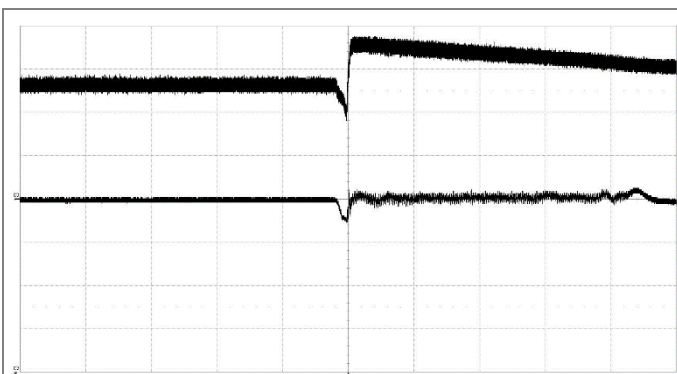

Output voltage response to input voltage  
 transient at:  $T_{P1} = +25^\circ\text{C}$ ,  $V_1 = 36\text{-}75\text{ V}$ ,  
 slew rate =  $0.1\text{ V}/\mu\text{s}$ ,  $I_o = 50\text{ A}$ ,  $C_o = 2\text{ mF}$

Top trace: input voltage (20 V/div.).  
 Bottom trace: output voltage (2 V/div.).  
 Time scale: (1 ms/div.).

**BMR458 series** Fully regulated DC/DC Converters  
 Input 36-75 V, Output up to 50 A / 600 W

1/28701-BMR458 0032 revA July 2018  
 © Flex

**BMR 458 0032/003**

**Typical Characteristics**  
**12 V, 50 A / 600 W**

**Output Current Derating – Open frame**

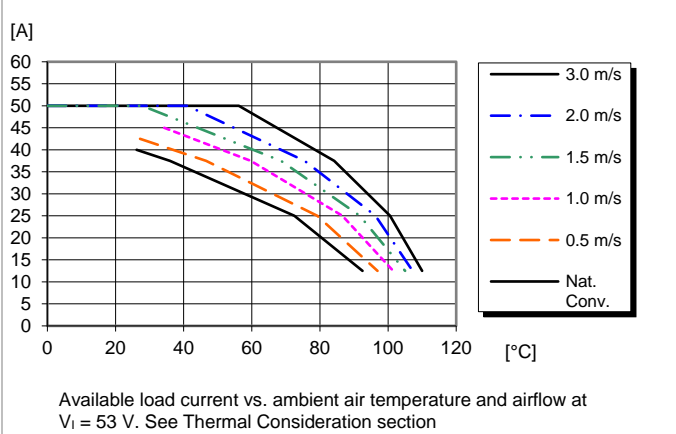

**Output Current Derating – Base plate**

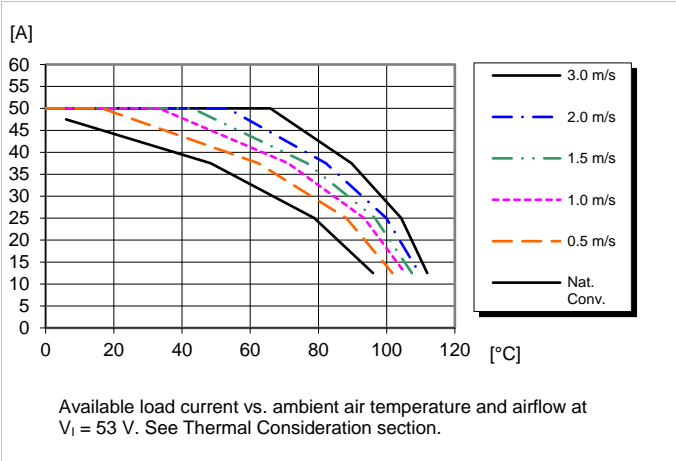

**Thermal Resistance – Base plate**

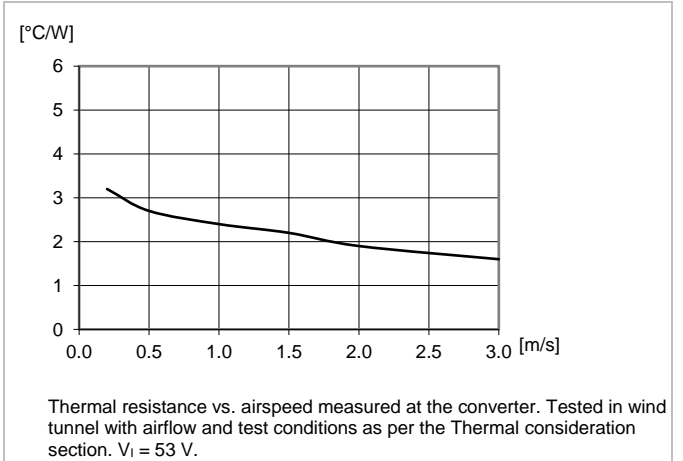

**Output Current Derating – Base plate and 1/2" Heat sink**

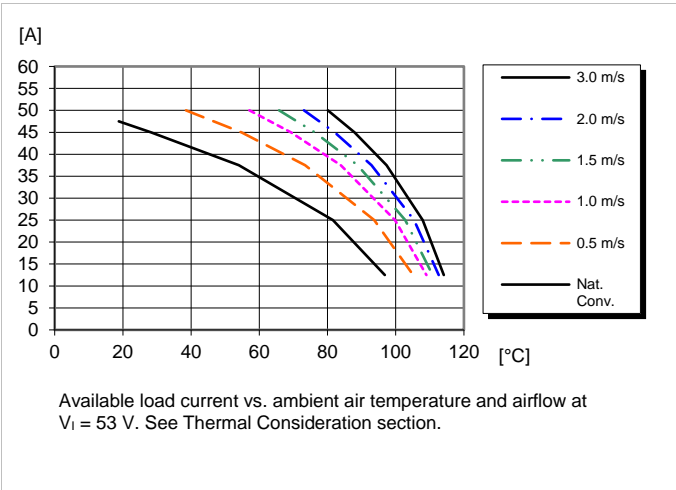

**Output Current Derating – Cold wall sealed box**

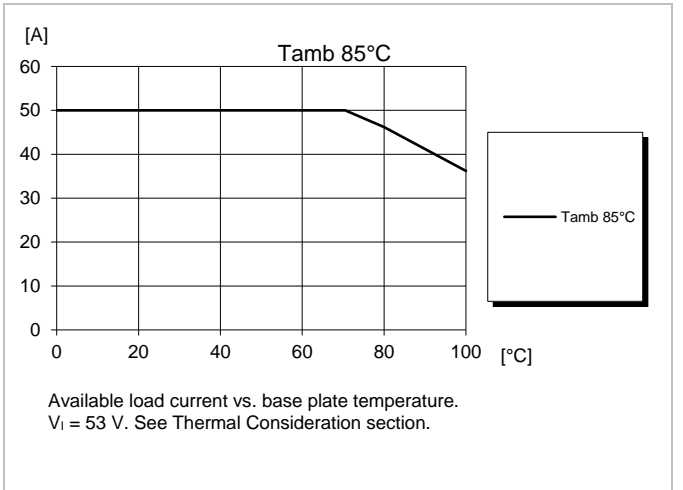

**BMR458 series Fully regulated DC/DC Converters**  
 Input 36-75 V, Output up to 50 A / 600 W

1/28701-BMR458 0032 revA July 2018  
 © Flex

**Electrical Specification**  
**12.45 V, 50 A / 600 W**

**BMR 458 0032/014**

$T_{P1} = -30$  to  $+95^{\circ}\text{C}$ ,  $V_I = 36$  to  $75$  V, sense pins connected to output pins unless otherwise specified under Conditions.  
 Typical values given at:  $T_{P1} = +25^{\circ}\text{C}$ ,  $V_I = 53$  V,  $I_O$  max, unless otherwise specified under Conditions.  
 Additional  $C_{in} = 220 \mu\text{F}$ ,  $C_{out} = 100 \mu\text{F}$ . See Operating Information section for selection of capacitor types.

Characteristics		Conditions	min	typ	max	Unit
$V_I$	Input voltage range		36		75	V
$V_{loff}$	Turn-off input voltage,	Decreasing input voltage	31	33	35	V
$V_{lon}$	Turn-on input voltage	Increasing input voltage	33	35	37	V
$C_I$	Internal input capacitance			15		$\mu\text{F}$
$P_O$	Output power		0		600	W
$\eta$	Efficiency	50% of max $I_O$		96.2		%
		max $I_O$		95.8		
		50% of max $I_O$ , $V_I = 48$ V		96.4		
		max $I_O$ , $V_I = 48$ V		95.8		
$P_d$	Power Dissipation	max $I_O$		26	37	W
$P_{li}$	Input idling power	$I_O = 0$ A, $V_I = 53$ V		4.8		W
$P_{RC}$	Input standby power	$V_I = 53$ V (turned off with RC)		0.85		W
$f_s$	Switching frequency	0-100 % of max $I_O$ see Note 1	174	180	186	kHz

$V_{Oi}$	Output voltage initial setting and accuracy	$T_{P1} = +25^{\circ}\text{C}$ , $V_I = 53$ V, $I_O = 0$ A	12.42	12.45	12.48	V
$V_O$	Output adjust range	See operating information	8		13.2	V
	Output voltage tolerance band	0-100% of max $I_O$	11.71		12.69	V
	Idling voltage	$I_O = 0$ A	12.35		12.55	V
	Line regulation	max $I_O$		30	50	mV
	Load regulation	$V_I = 53$ V, 0-100% of max $I_O$	450	500	550	mV
$V_{tr}$	Load transient voltage deviation	$V_I = 53$ V, Load step 25-75-25% of max $I_O$ , $di/dt = 5$ A/ $\mu\text{s}$ , $C_{out} = 5$ mF		$\pm 350$	$\pm 530$	mV
$t_{tr}$	Load transient recovery time				0.7	ms
$t_r$	Ramp-up time (from 0-100% of $V_{Oi}$ )	0-100% of max $I_O$		200		ms
$t_s$	Start-up time (from $V_I$ connection to 100% of $V_{Oi}$ )			230		ms
$t_{RC}$	RC start-up time (from $V_{RC}$ connection to 100% of $V_{Oi}$ )	max $I_O$		201		ms
RC	Sink current	See operating information	0.5			mA
	Trigger level			1.2		V
	Response time		0.4		1.1	ms
$I_O$	Output current		0		50	A
$I_{lim}$	Current limit threshold	$T_{P1} < \text{max } T_{P1}$	54	58	64	A
$I_{sc}$	Short circuit current	$T_{P1} = 25^{\circ}\text{C}$ , see Note 2		0		A
$C_{out}$	Recommended Capacitive Load	$T_{P1} = 25^{\circ}\text{C}$	100		15000	$\mu\text{F}$
$V_{Oac}$	Output ripple & noise	See ripple & noise section, $V_{Oi}$		130	250	mVp-p
OVP	Over voltage protection	$T_{P1} = +25^{\circ}\text{C}$ , $V_I = 53$ V, 0-100% of max $I_O$		15.6		V

Note 1: For higher values, contact FAE.

Note 2: Typical RMS current when BMR458 OCP is operating in latching mode.

**BMR458 series** Fully regulated DC/DC Converters  
 Input 36-75 V, Output up to 50 A / 600 W

1/28701-BMR458 0032 revA July 2018

© Flex

**Typical Characteristics**  
**12.45 V, 90 A / 1080 W**

**2 × BMR 458 0032/014**

**Efficiency**

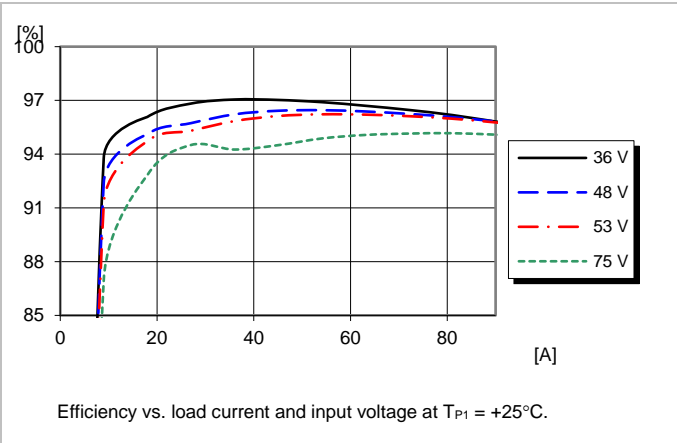

**Power Dissipation**

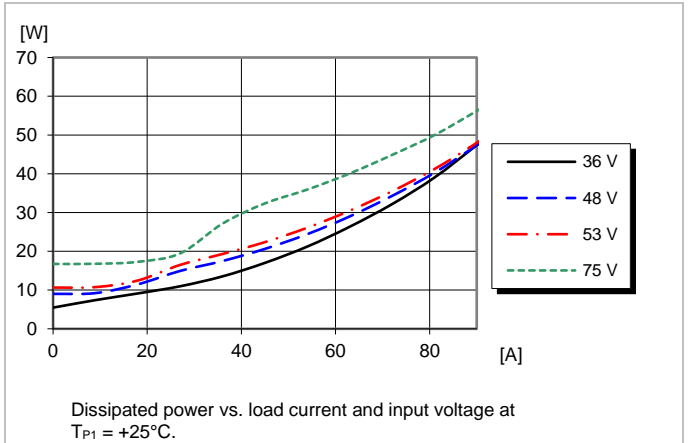

**Output Characteristics**

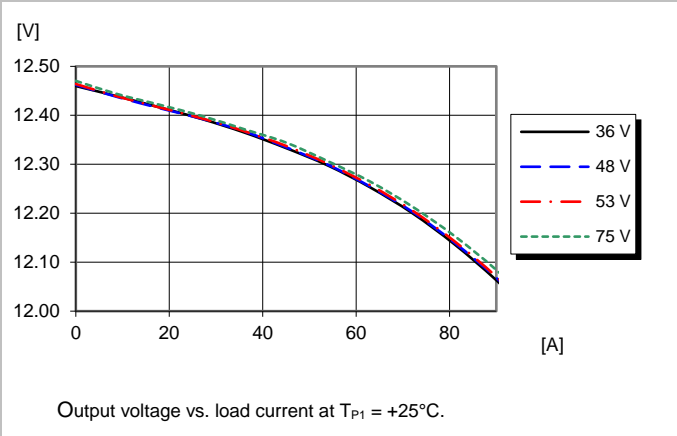

**Output Characteristics**

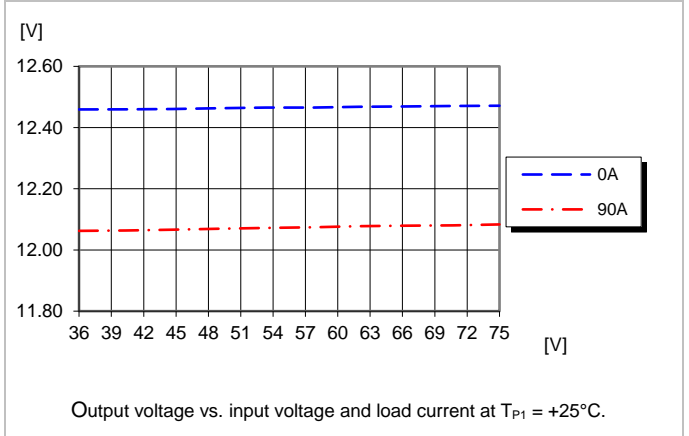

**Current Limit Characteristics**

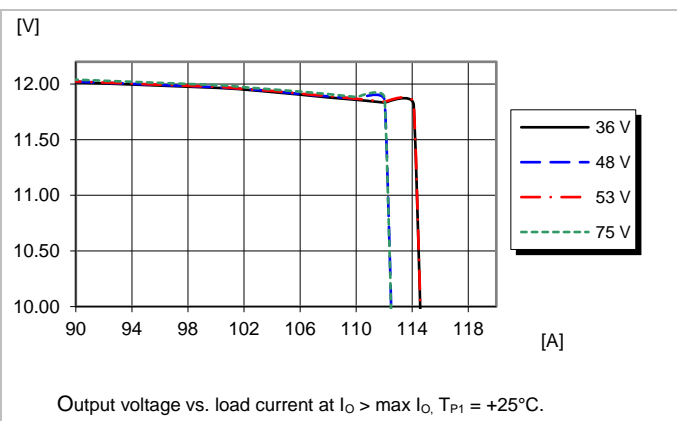

**BMR458 series** Fully regulated DC/DC Converters  
 Input 36-75 V, Output up to 50 A / 600 W

1/28701-BMR458 0032 revA July 2018  
 © Flex

**Typical Characteristics**  
**12.45 V, 90 A / 1080 W**

**2 × BMR 458 0032/014**

**Start-up**

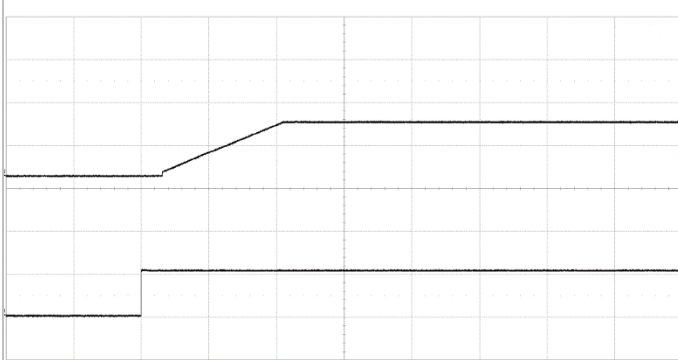

Start-up enabled by connecting  $V_I$  at:  
 $T_{P1} = +25^\circ\text{C}$ ,  $V_I = 53\text{ V}$ ,  
 $I_O = 90\text{ A}$  resistive load.

Top trace: output voltage (10 V/div.).  
 Bottom trace: input voltage (50 V/div.).  
 Time scale: (100 ms/div.).

**Shut-down**

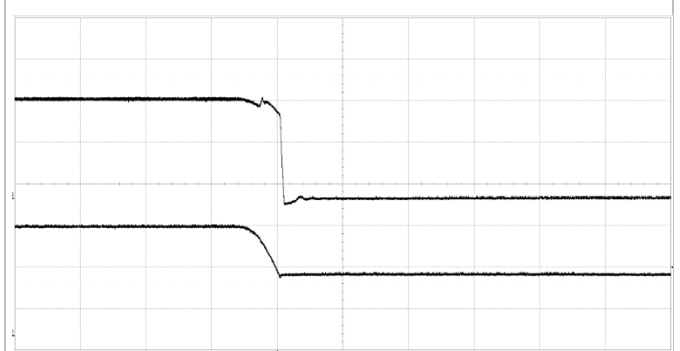

Shut-down enabled by disconnecting  $V_I$  at:  
 $T_{P1} = +25^\circ\text{C}$ ,  $V_I = 53\text{ V}$ ,  
 $I_O = 90\text{ A}$  resistive load.

Top trace: output voltage (5 V/div.).  
 Bottom trace: input voltage (20 V/div.).  
 Time scale: (1 ms/div.).

**Output Ripple & Noise**

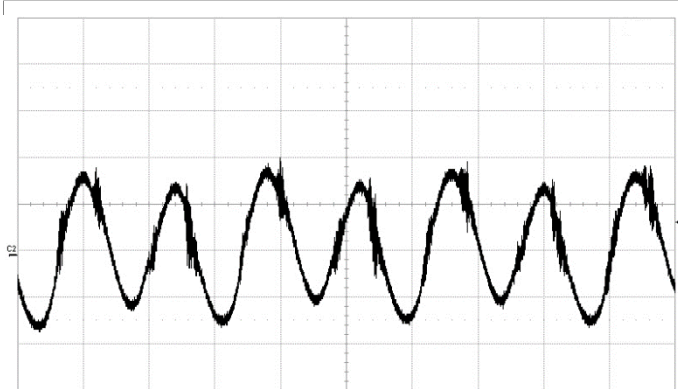

Output voltage ripple at:  
 $T_{P1} = +25^\circ\text{C}$ ,  $V_I = 53\text{ V}$ ,  
 $I_O = 90\text{ A}$  resistive load.

Trace: output voltage (20 mV/div.).  
 Time scale: (2  $\mu\text{s}$ /div.).

**Output Load Transient Response**

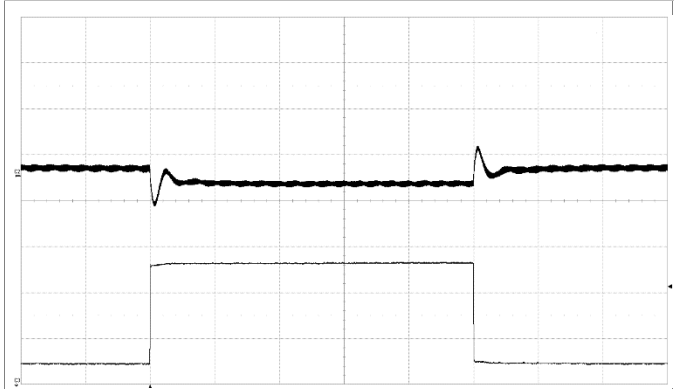

Output voltage response to load current step-  
 change (22.5-67.5-22.5 A) at:  
 $T_{P1} = +25^\circ\text{C}$ ,  $V_I = 53\text{ V}$ ,  $C_O = 5\text{ mF}$

Top trace: output voltage (500 mV/div.).  
 Bottom trace: load current (20 A/div.).  
 Time scale: (1 ms/div.).

**Input Voltage Transient Response**

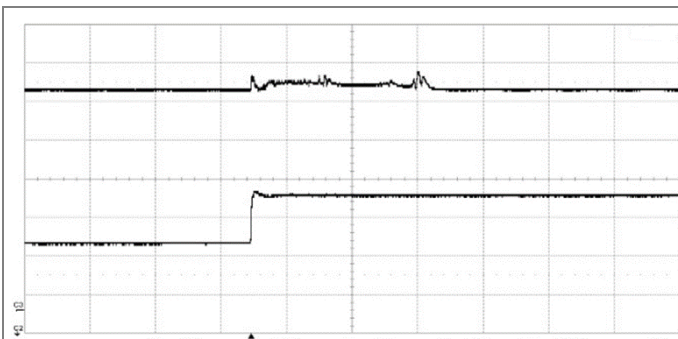

Output voltage response to input voltage  
 transient at:  $T_{P1} = +25^\circ\text{C}$ ,  $V_I = 36\text{-}60\text{ V}$ ,  
 slew rate =  $0.2\text{ V}/\mu\text{s}$ ,  $I_O = 90\text{ A}$ ,  $C_O = 5\text{ mF}$

Top trace: Output voltage (1 V/div.).  
 Bottom trace: Input voltage (20 V/div.).  
 Time scale: (5 ms/div.).

**BMR458 series** Fully regulated DC/DC Converters  
 Input 36-75 V, Output up to 50 A / 600 W

1/28701-BMR458 0032 revA July 2018

© Flex

### EMC Specification

Conducted EMI measured according to EN55022, CISPR 22 and FCC part 15J (see test set-up). The fundamental switching frequency is 180 kHz for BMR458. The EMI characteristics below is measured at  $V_1 = 53\text{ V}$  and max  $I_o$ .

#### Conducted EMI Input terminal value (typ)

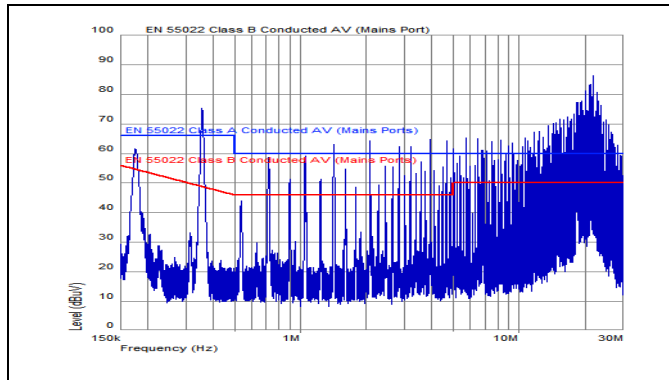

EMI without filter

#### Optional external filter for class B

Suggested external input filter in order to meet class B in EN 55022, CISPR 22 and FCC part 15J.

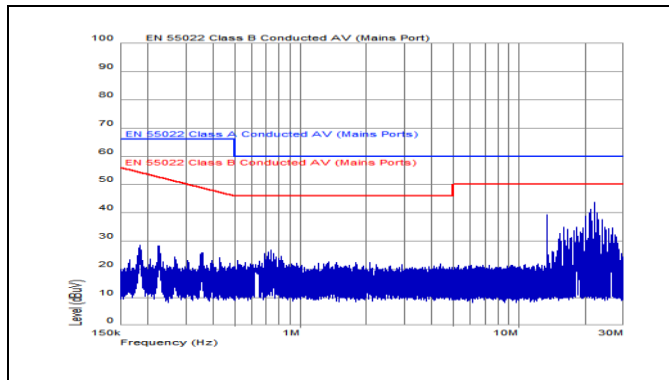
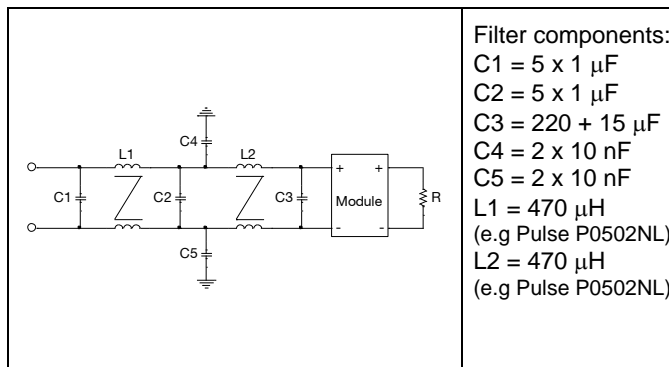

EMI with filter

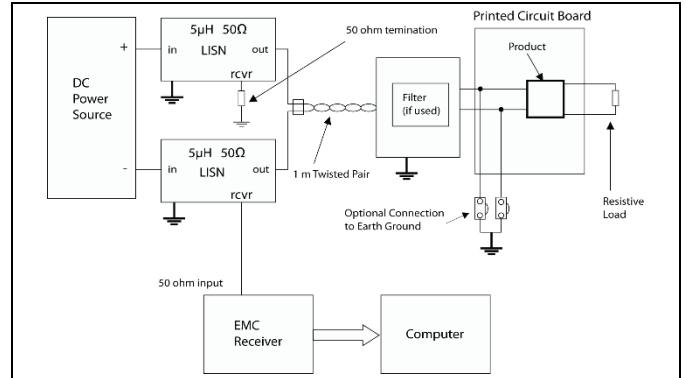

Test set-up

### Layout recommendations

The radiated EMI performance of the product will depend on the PWB layout and ground layer design. It is also important to consider the stand-off of the product. If a ground layer is used, it should be connected to the output of the product and the equipment ground or chassis.

A ground layer will increase the stray capacitance in the PWB and improve the high frequency EMC performance.

### Output ripple and noise

Output ripple and noise measured according to figure below. See Design Note 022 for detailed information.

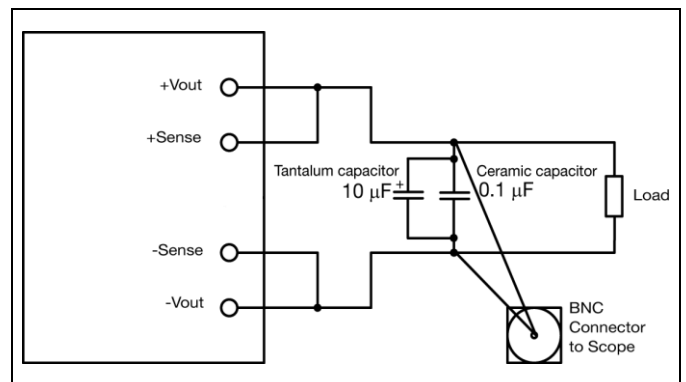

Output ripple and noise test setup



**BMR458 series** Fully regulated DC/DC Converters  
Input 36-75 V, Output up to 50 A / 600 W

1/28701-BMR458 0032 revA July 2018

© Flex

**Power Management Overview**

This product is equipped with a PMBus interface. The product incorporates a wide range of readable and configurable power management features that are simple to implement with a minimum of external components. Additionally, the product includes protection features that continuously safeguard the load from damage due to unexpected system faults. A fault is also shown as an alert on the SALERT pin. The following product parameters can continuously be monitored by a host: Input voltage, output voltage/current, duty cycle and internal temperature.

The product is delivered with a default configuration suitable for a wide range operation in terms of input voltage, output voltage, and load. The configuration is stored in an internal Non-Volatile Memory (NVM). All power management functions can be reconfigured using the PMBus interface

Throughout this document, different PMBus commands are referenced. A detailed description of each command is provided in the appendix at the end of this specification.

The Ericsson Power Designer software suite can be used to configure and monitor this product via the PMBus interface. For more information please contact your local Ericsson sales representative.

**SMBus Interface**

This product provides a PMBus digital interface that enables the user to configure many aspects of the device operation as well as to monitor the input and output voltages, output current and device temperature. The product can be used with any standard two-wire I<sup>2</sup>C or SMBus host device. In addition, the product is compatible with PMBus version 1.3 and includes an SALERT line to help mitigate bandwidth limitations related to continuous fault monitoring. The product supports 100 kHz and 400 kHz bus clock frequency only. The PMBus signals, SCL, SDA and SALERT require passive pull-up resistors as stated in the SMBus Specification. Pull-up resistors are required to guarantee the rise time as follows:

$$\text{Eq. 7} \quad \tau = R_p C_p \leq 1\mu s$$

where  $R_p$  is the pull-up resistor value and  $C_p$  is the bus load. The maximum allowed bus load is 400 pF. The pull-up resistor should be tied to an external supply between 2.7 to 5.5 V, which should be present prior to or during power-up. If the proper power supply is not available, voltage dividers may be applied. Note that in this case, the resistance in the equation above corresponds to parallel connection of the resistors forming the voltage divider.

It is recommended to always use PEC (Packet Error Check) when communicating via PMBus.

**PMBus Addressing**

The following figure and table show recommended resistor values with min and max voltage range for hard-wiring PMBus addresses (series E12, 1% tolerance resistors suggested):

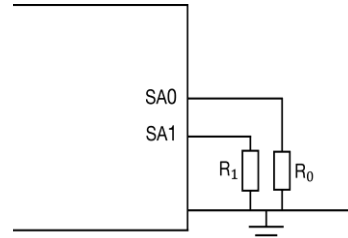

Schematic of connection of address resistors

SA0/SA1 Index	R <sub>SA0</sub> /R <sub>SA1</sub> [kΩ]
0	10
1	22
2	33
3	47
4	68
5	100
6	150
7	220

The SA0 and SA1 pins can be configured with a resistor to GND according to the following equation.

$$\text{PMBus Address (decimal)} = 8 \times (\text{SA0 index}) + (\text{SA1 index})$$

If the calculated PMBus address is 0, 11 or 12, PMBus address 127 is assigned instead. From a system point of view, the user shall also be aware of further limitations of the addresses as stated in the PMBus Specification. It is not recommended to keep the SA0 and SA1 pins left open. There is an option to only use SA0 as address pin, see section MFR\_OFFSET\_ADDRESS how to set the command to utilize single address pin option.

**I<sup>2</sup>C/SMBus – Timing**

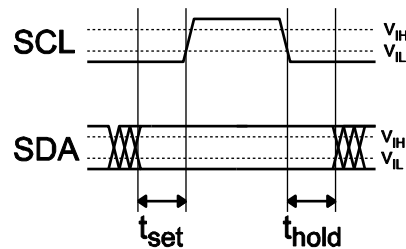

Setup and hold times timing diagram

The setup time,  $t_{set}$ , is the time data, SDA, must be stable before the rising edge of the clock signal, SCL. The hold time  $t_{hold}$ , is the time data, SDA, must be stable after the rising edge of the clock signal, SCL. If these times are violated incorrect data may be captured or meta-stability may occur and the bus communication may fail. All standard SMBus protocols must be followed, including clock stretching. This product supports the BUSY flag in the status commands to indicate product being too busy for SMBus response. A bus-free time delay

**BMR458 series Fully regulated DC/DC Converters**  
 Input 36-75 V, Output up to 50 A / 600 W

1/28701-BMR458 0032 revA July 2018

© Flex

between every SMBus transmission (between every stop & start condition) must occur. Refer to the SMBus specification, for SMBus electrical and timing requirements. Note that an additional delay of 5 ms has to be inserted in case of storing the RAM content into the internal non-volatile memory.

### Monitoring via PMBus

It is possible to continuously monitor a wide variety of parameters through the PMBus interface. These include, but are not limited to, the parameters listed in the table below.

Parameter	PMBus Command
Input voltage	READ_VIN
Output voltage	READ_VOUT
Output current	READ_IOUT
Temperature *	READ_TEMPERATURE_1
Switching Frequency	READ_FREQUENCY
Duty cycle	READ_DUTY_CYCLE

\*Reports the temperature from temperature sensor set in command 0xDC, internal (controller IC)/external (temp sensor).

### Monitoring Faults

Fault conditions can be detected using the SALERT pin, which will be asserted low when any number of pre-configured fault or warning conditions occurs. The SALERT pin will be held low until faults and/or warnings are cleared by the CLEAR\_FAULTS command, or until the output voltage has been re-enabled. It is possible to mask which fault conditions should not assert the SALERT pin by the command SMBALERT\_MASK. In response to the SALERT signal, the user may read a number of status commands to find out what fault or warning condition occurred, see table below.

Fault & Warning Status	PMBus Command
Overview, Power Good	STATUS_BYTE STATUS_WORD
Output voltage level	STATUS_VOUT
Output current level	STATUS_IOUT
Input voltage level	STATUS_INPUT
Temperature level	STATUS_TEMPERATURE
PMBus communication	STATUS_CML
Miscellaneous	STATUS_MFR_SPECIFIC

### Snapshot Parameter Capture

When input voltage disappears during conversion the Snapshot functionality will automatically store parametric RAM data to NVM. After one successful ramp with Vin still in the operating range, the snap shot data contains only FFh. To be able to retrieve snap shot data from the previous power cycle, it is therefore important to eliminate ramp up e.g by turning RC off or keeping Vin at 30V. The NVM data can be read back using the MFR\_GET\_SNAPSHOT 0xD7 command to provide valuable information for analysis. The snap shot parameters called old are the recorded values at the fault event. All other snap shot parameters are stored to NVM when Vi falls below

V<sub>loff</sub> level. Theoretically the snapshot could be corrupted by a very fast Vin drop. Following parameters are stored to NVM:

- Input voltage old
- Output voltage old
- Output current old
- Duty cycle old
- Input voltage
- Output voltage
- Output current
- Temperature\_1 (sensor select in 0xDC)
- Temperature\_2
- Time in operation
- Status\_word
- Status\_byte
- Status\_Vout
- Status\_Iout
- Status\_Temperature
- Status\_CML
- Status\_Other
- Status\_MFR\_Specific
- Snap shot cycles

Read MFR\_GET\_SNAPSHOT using the Ericsson Power Designer.

### Ramp up data Capture

The command MFR\_GET\_RAMP\_DATA 0xDB retrieves 32 bytes of ramp data. 15 pairs of instant values of Vin and Vout are recorded during ramp and the interval is adjusted to the ramp time. Data byte 1 & 2 is the counter. Instant values of Vin & Vout are recorded as 8 bit integers, data byte 3 is the first Vin sample and data byte 4 is the first Vout sample. Vin & Vout are recorded as pairs until the ramp is finished. The record counter value is recorded just before ramp. The record value is equal to last value of "snap shot cycles" + 1. This way it can be judged whether the ramp data was recorded before or after snap shot data. Only the first ramp in a power cycle will be recorded. If the read out of the 32 bytes are all FFh then it is a successful ramp-up. Only the first ramp in a power cycle will be recorded. Thus if the ramp fails, consequent ramp attempts will not be recorded and bit 6 in STATUS\_MFR\_SPECIFIC will be set. Read MFR\_GET\_RAMP\_DATA using Ericsson Power Designer.

### Status data Capture

The command MFR\_GET\_STATUS\_DATA 0xDF retrieves 32 bytes consisting of a power cycle counter and 15 status words. The recording starts just after ramp has finished. Firstly, the power cycle counter is retrieved from the ramp data and stored as the first word. Secondly the status word is stored. The unit then continues to store status words every ~8 sec intervals. Total recording time is ~8 \* 15 ~ 120 s.

### Non-Volatile Memory (NVM)

The product incorporates two Non-Volatile Memory areas for storage of the PMBus command values; the Default NVM and the User NVM. The Default NVM is pre-loaded with Ericsson factory default values. The Default NVM is write-protected and

<b>BMR458 series Fully regulated DC/DC Converters</b> Input 36-75 V, Output up to 50 A / 600 W	1/28701-BMR458 0032 revA July 2018
	© Flex

can be used to restore the Ericsson factory default values through the command `RESTORE_DEFAULT_ALL`. The User NVM is pre-loaded with Ericsson factory default values. The User NVM is writable and open for customization. The values in NVM are loaded during initialization according to section Initialization Procedure, where after commands can be changed through the PMBus Interface. The `STORE_USER_ALL` command will store the changed parameters to the User NVM.

## Operating Information

### Input Voltage

The input voltage range 36 to 75 Vdc meets the requirements for normal input voltage range in  $-48$  Vdc and  $-60$  Vdc systems,  $-40.5$  to  $-57.0$  V and  $-50.0$  to  $-72$  V respectively. At input voltages exceeding 75 V, the power loss will be higher than at normal input voltage and  $T_{P1}$  must be limited to absolute max  $+125^{\circ}\text{C}$ . The absolute maximum continuous input voltage is 80 Vdc.

Short duration transient disturbances can occur on the DC distribution and input of the product when a short circuit fault occurs on the equipment side of a protective device (fuse or circuit breaker). The voltage level, duration and energy of the disturbance are dependent on the particular DC distribution network characteristics and can be sufficient to damage the product unless measures are taken to suppress or absorb this energy. The transient voltage can be limited by capacitors and other energy absorbing devices like zener diodes connected across the positive and negative input conductors at a number of strategic points in the distribution network. The end-user must secure that the transient voltage will not exceed the value stated in the Absolute maximum ratings. ETSI TR 100 283 examines the parameters of DC distribution networks and provides guidelines for controlling the transient and reduce its harmful effect.

### Turn-on and -off Input Voltage

The products monitor the input voltage and will turn on and turn off at configured thresholds (see Electrical Specification). The turn-on input voltage voltage threshold is set higher than the corresponding turn-off threshold. Hence, there is a hysteresis between turn-on and turn-off input voltage levels. The minimum hysteresis between turn on and turn off input voltage is 1V.

### Remote Control (RC)

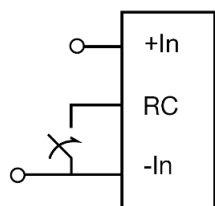

The products are fitted with a remote control function referenced to the primary negative input connection ( $-In$ ), with negative and positive logic options available. The RC function allows the product to be turned on/off by an external device like a semiconductor or mechanical switch.

The external device must provide a minimum required sink current  $>0.5$  mA to guarantee a voltage not higher than maximum voltage on the RC pin (see Electrical characteristics table). To turn off the product the RC pin should be left open for a minimum of time 150  $\mu\text{s}$ , the same time requirement applies when the product shall turn on. When the RC pin is left open, the voltage generated on the RC pin is max 5 V, via an internal pull up resistor. The logic option for the primary remote control is easily configured via `0xE3` command using Ericsson Power Designer. The standard product is provided with "negative logic" RC and will be off until the RC pin is connected to the  $-In$ . To turn off the product the RC pin should be left open. In situations where it is desired to have the product to power up automatically without the need for control signals or a switch, the RC pin can be wired directly to  $-In$ .

### Remote Control (secondary side)

The CTRL-pin can be configured as remote control via the PMBus interface. In the default configuration the CTRL-pin is disabled and floating. The output can be configured to internal pull-up to 3.3 V using the `MFR_MULTI_PIN_CONFIG (0xF9)` command. The CTRL-pin can be left open when not used. The logic options for the secondary remote control can be positive or negative logic. The logic option for the secondary remote control is easily configured via `ON_OFF_CONFIG (0x02)` using Ericsson Power Designer software command, see also `MFR_MULTI_PIN_CONFIG` section.

### Input and Output Impedance

The impedance of both the input source and the load will interact with the impedance of the product. It is important that the input source has low characteristic impedance. Minimum recommended external input capacitance is 100  $\mu\text{F}$ . The electrolytic capacitors will be degraded in low temperature. The needed input capacitance in low temperature should be equivalent to 100  $\mu\text{F}$  at  $20^{\circ}\text{C}$ . The performance in some applications can be enhanced by addition of external capacitance as described under External Decoupling Capacitors. If the input voltage source contains significant inductance, the addition of a 22 – 100  $\mu\text{F}$  capacitor across the input of the product will ensure stable operation. The minimum required capacitance value depends on the output power and the input voltage. The higher output power the higher input capacitance is needed.

### External Decoupling Capacitors

When powering loads with significant dynamic current requirements, the voltage regulation at the point of load can be improved by addition of decoupling capacitors at the load. The most effective technique is to locate low ESR ceramic and electrolytic capacitors as close to the load as possible, using several parallel capacitors to lower the effective ESR. The ceramic capacitors will handle high-frequency dynamic load changes while the electrolytic capacitors are used to handle low frequency dynamic load changes. It is equally important to use low resistance and low inductance PWB layouts and cabling. External decoupling capacitors will become part of the product's control loop. The control loop is optimized for a wide

<b>BMR458 series Fully regulated DC/DC Converters</b> Input 36-75 V, Output up to 50 A / 600 W	1/28701-BMR458 0032 revA July 2018
	© Flex

range of external capacitance and the maximum recommended value that could be used without any additional analysis is found in the Electrical specification.

The ESR of the capacitors is a very important parameter. Stable operation is guaranteed with a verified ESR value of  $>1$  m $\Omega$  across the output connections.

For further information please contact your local Ericsson Power Modules representative.

### Remote Sense

The products have remote sense that can be used to compensate for voltage drops between the output and the point of load. The sense traces should be located close to the PWB ground layer to reduce noise susceptibility. The remote sense circuitry will compensate a voltage drop between output pins and the point of load that is as high as 10% of the output voltage.

If the remote sense is not needed +Sense should be connected to +Out and -Sense should be connected to -Out. To be able to use remote sense the converter must be equipped with a digital header.

### PMBus configuration and support

The product provides a PMBus digital interface that enables the user to configure many aspects of the device operation as well as monitor the input and output parameters. The Ericsson Power Designer software suite can be used to configure and monitor this product via the PMBus interface. For more information, please contact your local Ericsson sales representative.

### Feed Forward Capability

The BMR458 products have a Feed Forward function implemented that can handle sudden input voltage changes. The output voltage will be regulated during an input transient and will typically stay within 10%, when an input transient is applied. The Feed Forward acts on both positive and negative input voltage transients. The function can easily be configured to be enabled/disabled. For more information, please contact your local Ericsson sales representative.

### Output Voltage Adjust using PMBus

The output voltage of the product can be reconfigured via PMBus command 0x21 (VOUT\_COMMAND) or 0x22 (VOUT\_TRIM). This can be used to adjust the output voltage above or below output voltage initial setting up to a certain level, see Electrical specification for adjustment range. When increasing the output voltage, the voltage at the output pins (including any remote sense compensation) must be kept within the plotted area, see graph. Output voltage setting must be kept below the threshold of the over voltage protection, (OVP) to prevent the product from shutting down. At increased output voltages the maximum power rating of the product remains the same, and the max output current must be decreased correspondingly.

### Margin Up/Down Controls

These controls allow the output voltage to be momentarily adjusted, either up or down, by a nominal 10%. This provides a convenient method for dynamically testing the operation of the load circuit over its supply margin or range. It can also be used to verify the function of supply voltage supervisors. The margin up and down levels of the product can be easily be re-configured using Ericsson Power Designer software.

### Soft-start Power Up

When starting by applying input voltage the control circuit boot-up time adds an additional 25 ms delay. The soft-start and soft-off control functionality allows the output voltage to ramp-up and ramp-down with defined timing with respect to the control of the output. This can be used to control inrush current and manage supply sequencing of multiple controllers. The rise time is the time taken for the output to ramp to its target voltage, while the fall time is the time taken for the output to ramp down from its regulation voltage to 0 V. The on delay time sets a delay from when the output is enabled until the output voltage starts to ramp up. The off delay time sets a delay from when the output is disabled until the output voltage starts to ramp down.

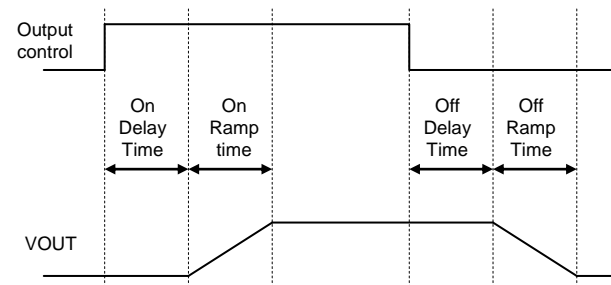

Illustration of Soft-Start and Soft-Stop.

By default, soft-off is disabled and the converter is turned off immediately when the output is disabled. Soft-off can be enabled through the PMBus command ON\_OFF\_CONFIG. The delay and ramp times can be reconfigured using the PMBus commands TON\_DELAY, TON\_RISE, TOFF\_DELAY and TOFF\_FALL.

### Pre-bias Start-up

The product has a Pre-bias start up functionality and will not sink current during start up if a pre-bias source is present at the output terminals. If the Pre-bias voltage is lower than the target value set in VOUT\_COMMAND (0x21), the product will ramp up to the target value. If the Pre-bias voltage is higher than the target value set in VOUT\_COMMAND (0x21), the product will ramp down to the target value and in this case sink current for a time interval set by the command TOFF\_MAX\_WARN\_LIMIT (0x66).

### Parallel Operation DLS (Droop Load Share)

Two or more products may be paralleled for redundancy if the total power is equal or less than  $P_{O\max}$ . The products provide output voltage droop corresponding to pre-configured artificial

**BMR458 series Fully regulated DC/DC Converters**  
 Input 36-75 V, Output up to 50 A / 600 W

1/28701-BMR458 0032 revA July 2018  
 © Flex

resistance in the output circuit to enable direct paralleling. The stated output voltage set point is at no load. The output voltage will decrease when the load current is increased. This feature allows the products to be connected in parallel and share the current with 10% accuracy at max output power. This means that up to 90% of max rated current from each module can be utilized. The product measures reversed current, and will compensate the output voltage in these situations. At reversed current > 35A the product will shut down immediately. Note that continuous restarts after a fault (“hiccup mode”) are not recommended for parallel operation. Droop Load Share variants (DLS) will have a default response from an OCP fault consisting of a response delay of 2ms then immediately shut down. To prevent unnecessary current stress, changes of the output voltage must be done with the output disabled. This must be considered for all commands that affect the output voltage.

Parallel operation is easily configured using Ericsson Power Designer software. See application note AN324 for further information.

Parallel operation (DLS)

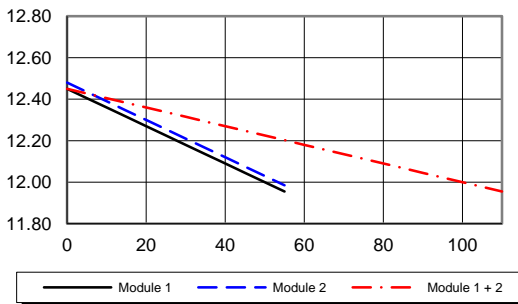

**Over/Under Temperature Protection (OTP, UTP)**

The products are protected from thermal overload by an internal over temperature sensor. When  $T_{P1}$  as defined in thermal consideration section exceeds 125°C the product will shut down. The temperature sensor is located close to  $T_{P1}$ . The OTP limit is set to 125°C and trigger when the temperature reaches 125°C on the temperature sensor. The product will make continuous attempts to start up (non-latching mode) and resume normal operation automatically when the temperature has dropped below the temperature threshold set in command 0x51 OT\_WARN\_LIMIT.

The OTP and hysteresis of the product can be re-configured using the PMBus interface. The product has also an under temperature protection. The OTP and UTP fault limit and fault response can be configured via the PMBus. Note: using the fault response “continue without interruption” may cause permanent damage to the product.

**Input Over/Under Voltage Protection**

The input of the product can be protected from high input voltage and low input voltage. The over/under-voltage fault level and fault response is easily configured using Ericsson

Power Designer software, see also Appendix – PMBus commands.

**Output Over Voltage Protection (OVP)**

The product includes over voltage limiting circuitry for protection of the load. The default OVP limit is 30% above the nominal output voltage. If the output voltage exceeds the OVP limit, the product can respond in different ways. The default response from an over voltage fault is to immediately shut down. The device will continuously check for the presence of the fault condition, and when the fault condition no longer exists the device will be re-enabled. The OVP fault level and fault response can be configured via the PMBus interface, see Appendix – PMBus commands.

**Over Current Protection (OCP)**

The products include current limiting circuitry for protection at continuous overload. For standard configuration the output voltage will decrease towards  $0.3 \times V_{out}$ , set in command IOUT\_OC\_LV\_FAULT\_LIMIT (0x48), then shutdown and automatic restart for output currents in excess of max output current (max  $I_o$ ). The product will resume normal operation after removal of the overload. The load distribution should be designed for the maximum output short circuit current specified.

The over current protection of the product can be configured via the PMBus interface, see Appendix – PMBus commands.

**Synchronization**

It is possible to synchronize the product together with other BMR458 products by connecting SYNC signal that can be configured to be at pin 12 or pin 9, (see Multi Pin Configuration) between the products. To utilize the synchronization one product must be configured to output sync. The other products will be configured as sync in. The function is enabled and configured to be sync out or sync in by setting MFR\_MULTI\_PIN\_CONFIG. The synchronization can be configured to use interleaving between the switching phases. Synchronization can be configured via the PMBus interface, see Appendix – PMBus commands, MFR\_MULTI\_PIN\_CONFIG (0xF9).

**Interleave**

When multiple product share a common DC input supply, spreading of the switching phases between the products can be utilized. This reduces the input capacitance requirements and efficiency losses, since the peak current drawn from the input supply is effectively spread out over the whole switch period. If two or more units have their outputs connected in parallel, interleaving will reduce ripple currents. This requires that the products are synchronized using the SYNC pin. Interleave function can be configured via the PMBus interface, see Appendix – PMBus commands, INTERLEAVE (0x37). The default configuration is set to 0x0021.

Byte	High Byte						Low Byte									
Bit Number	7	6	5	4	3	2	1	0	7	6	5	4	3	2	1	0
Contents	Not Used			Group ID Number			Number In Group			Interleave Order						
Default Value	00			00			00			00						

**BMR458 series** Fully regulated DC/DC Converters  
Input 36-75 V, Output up to 50 A / 600 W

1/28701-BMR458 0032 revA July 2018

© Flex

$$Phase\_offset(^{\circ}) = 360^{\circ} \times \frac{Interleave\_order}{Number\_in\_group}$$

For more details about how to setup Interleave, refer to the PMBus specification.

### Switching frequency

The switching frequency is set to 180kHz as default but this can be reconfigured via the PMBus interface. The product is optimized at this frequency, but can run at lower and higher frequency (160kHz-200kHz). The electrical performance can be affected if the switching frequency is changed.

### Power Good

The power good pin 6(PG\_SYNC) indicates when the product is ready to provide regulated output voltage to the load. During ramp-up and during a fault condition, PG is held high. By default, PG is asserted low after the output has ramped to a voltage above 8V, and de-asserted if the output voltage falls below 5V. These thresholds may be changed using the PMBus commands POWER\_GOOD\_ON and POWER\_GOOD\_OFF.

By default, the PG pin is configured as Push/pull output but it is also possible to set the output in open drain mode by the command MFR\_MULTI\_PIN\_CONFIG (0xF9), see Appendix – PMBus commands.

The polarity is by default configured to active low, the polarity of PG can be set to active high in the command MFR\_PGOOD\_POLARITY (0xD0):  
0xD0 = 00 (active low)  
0xD0 = 01 (active high)

The product provides Power Good flag in the Status Word register that indicates the output voltage is within a specified tolerance of its target level and no fault condition exists.

It is not recommended to use Push-pull when paralleling PG-pins.

### DBV (Dynamic Bus Voltage)

The MFR\_DBV\_CONFIG 0xEF command can be used when the output voltage shall change depending on the output current load, which can improve the energy consumption. In MFR\_DBV\_CONFIG there are 4 current thresholds, low to mid (I1H), mid to low (I1L), mid to high (I2H) and high to mid (I2L) and 2 voltage levels that can be set, V1 and V2, V3 is the default setting in VOUT\_COMMAND (0x21).

The Vout rise time is configured via VOUT\_TRANSITION\_RATE (0x27), consider that the max output current or power can't be exceeded when entering different Vout levels.

The MFR\_DBV\_CONFIG is easily configured using Ericsson Power Designer software, see also Appendix – PMBus commands.

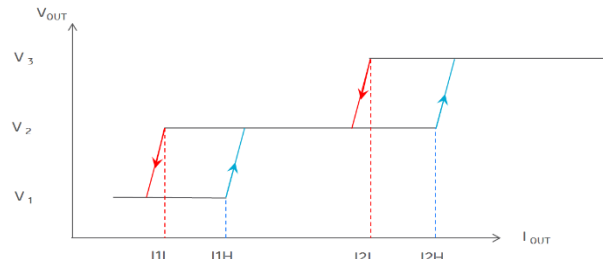

### ART (Adaptive Ramp-up Time)

MFR\_DLC\_CONFIG 0xF7 command combines ART and DLC functions. This section describes the ART function. It can be useful when adaptive rise time is requested, referenced to the output capacitive load.

From start of ramp-up, TON\_RISE is used. V\_end and V\_start state the levels on the ramp where the output capacitance is measured. The values K1, K2 and K3 set the ramp factor multiplied to the default TON\_RISE value. The ramp factor is referenced to Limit1, Limit2 and Limit3 stated in MFR\_DLC\_CONFIG.

The MFR\_DLC\_CONFIG is easily configured using Ericsson Power Designer software, see also Appendix – PMBus commands.

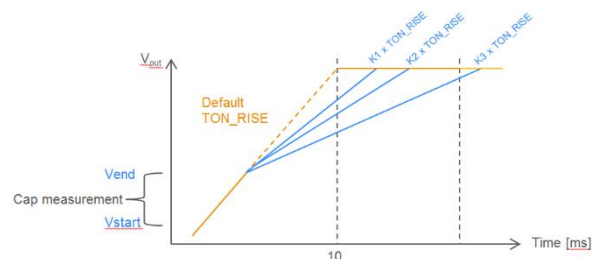

### DLC (Dynamic Load Compensation)

MFR\_DLC\_CONFIG 0xF7 command combines ART and DLC functions. This section describes the DLC function. The DLC function is useful when optimized parameters for the control loop is requested, referenced to the output capacitive load. Only if the output capacitance is larger than Limit3 the control loop will be changed.

V\_end and V\_start state the levels on the ramp where the output capacitance is measured. At the end of this measurement the control loop can possibly change depending on the configuration.

The MFR\_DLC\_CONFIG is easily configured using Ericsson Power Designer, see also Appendix – PMBus commands.

### Multi pin configuration

The MFR\_MULTI\_PIN\_CONFIG (0xF9) command can be re-configured using the PMBus interface to enable or disable different functions and set the pin configuration of the digital

<b>BMR458 series</b> Fully regulated DC/DC Converters Input 36-75 V, Output up to 50 A / 600 W	1/28701-BMR458 0032 revA	July 2018
	© Flex	

interface (pin 6 and pin9-15), see Appendix – PMBus commands. Standard configuration for stand-alone product is set to Power Good Push/pull (0x04). Products that are configured for parallel operation have Power Good configured to Open Drain (0x06).

#### Address Offset

The command MFR\_OFFSET\_ADDRESS 0xEE enables to use only 1 external address pin, SA0. This option can be utilized via MFR\_MULTI\_PIN\_CONFIG 0xF9 when the address pin SA1 will be used as SYNC IN/OUT. The PMBus-address offset increments with the value stated in 0xEE and referenced to resistor value set to SA0 pin, see PMBus addressing. The address offset is set in command 0xEE, see Appendix – PMBus commands.

**BMR458 series** Fully regulated DC/DC Converters  
 Input 36-75 V, Output up to 50 A / 600 W

1/28701-BMR458 0032 revA July 2018  
 © Flex

**Thermal Consideration**

**General**

The products are designed to operate in different thermal environments and sufficient cooling must be provided to ensure reliable operation.

For products mounted on a PWB without a heat sink attached, cooling is achieved mainly by conduction, from the pins to the host board, and convection, which is dependent on the airflow across the product. Increased airflow enhances the cooling of the product. The Output Current Derating graph found in the Output section for each model provides the available output current vs. ambient air temperature and air velocity at  $V_I = 53 V$ .

The product is tested on a 254 x 254 mm, 35  $\mu m$  (1 oz), 16-layer test board mounted vertically in a wind tunnel with a cross-section of 608 x 203 mm.

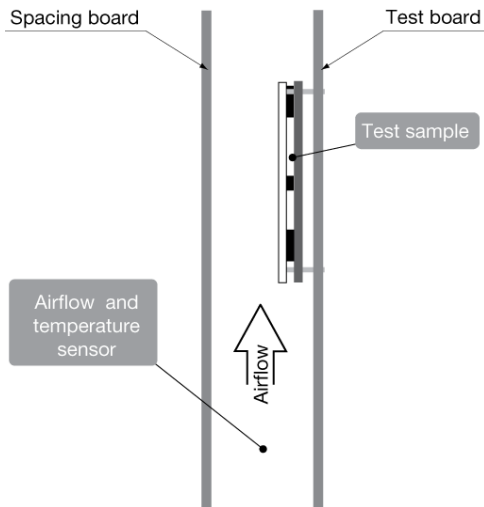

For products with base plate used in a sealed box/cold wall application, cooling is achieved mainly by conduction through the cold wall. The Output Current Derating graphs are found in the Output section for each model. The product is tested in a sealed box test set up with ambient temperatures 85°C. See Design Note 028 for further details.

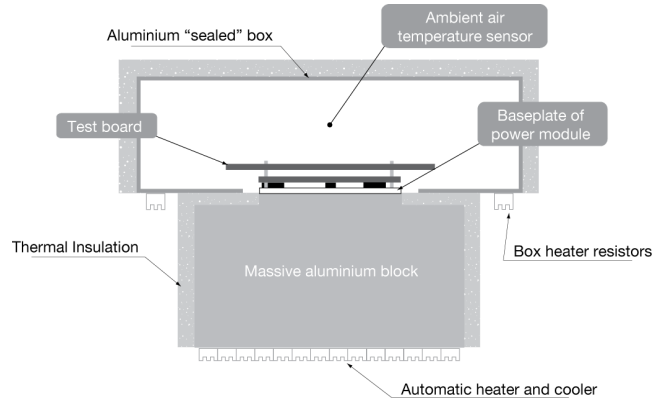

**Definition of product operating temperature**

The product operating temperatures is used to monitor the temperature of the product, and proper thermal conditions can be verified by measuring the temperature at positions P1, P2, and P3. The temperature at these positions ( $T_{P1}$ ,  $T_{P2}$ ,  $T_{P3}$ ) should not exceed the maximum temperatures in the table below. The number of measurement points may vary with different thermal design and topology. Temperatures above maximum  $T_{P1}$ , measured at the reference point P1 are not allowed and may cause permanent damage.

Position	Description	Max Temp.
P1	PWB (reference point, open frame)	$T_{P1}=125^{\circ} C$
P2	PWB reference point, base-plate version)	$T_{P2}=125^{\circ} C$
P3	MOSFET case	$T_{P3}=125^{\circ} C$

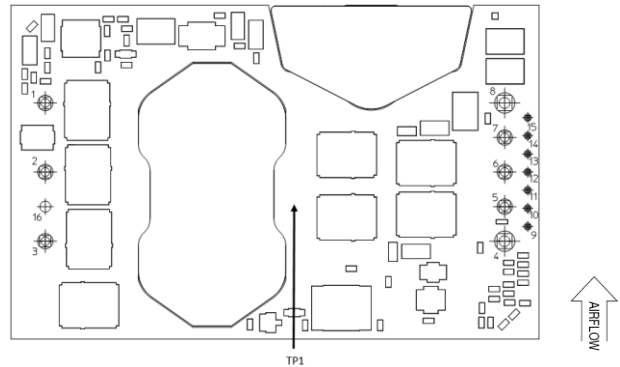

Open frame(Top view)



**BMR458 series** Fully regulated DC/DC Converters  
 Input 36-75 V, Output up to 50 A / 600 W

1/28701-BMR458 0032 revA

July 2018

© Flex

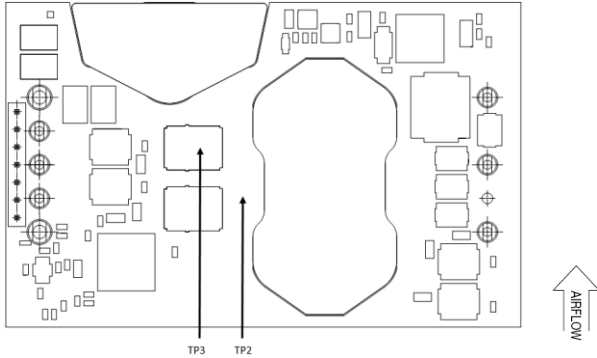

Base plate (Bottom view)

### Connections (Top view)

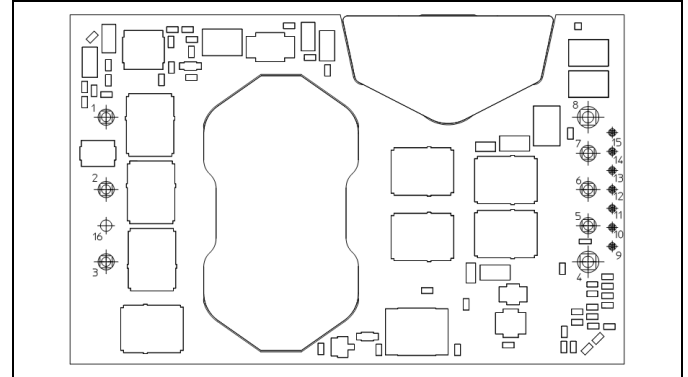

### Ambient Temperature Calculation

For products with base plate the maximum allowed ambient temperature can be calculated by using the thermal resistance.

- The power loss is calculated by using the formula  $((1/\eta) - 1) \times \text{output power} = \text{power losses (Pd)}$ .  
 $\eta$  = efficiency of product. E.g. 96% = 0.96
- Find the thermal resistance (Rth) in the Thermal Resistance graph found in the Output section for each model. **Note that the thermal resistance can be reduced if a heat sink is mounted on the top of the base plate.**

Calculate the temperature increase ( $\Delta T$ ).  
 $\Delta T = R_{th} \times P_d$

3. Max allowed ambient temperature is:  
 $\text{Max } T_{P1} - \Delta T$ .

E.g. BMR 458 0032 at 1.5m/s:

1.  $((\frac{1}{0.95}) - 1) \times 600 \text{ W} = 31.6 \text{ W}$

2.  $31.6 \text{ W} \times 2.2^\circ\text{C/W} = 69.5^\circ\text{C}$

3.  $125^\circ\text{C} - 69.5^\circ\text{C} = \text{max ambient temperature is } 55.5^\circ\text{C}$

4. The thermal performance can be improved by mounting a heat sink on top of the base plate.

The actual temperature will be dependent on several factors such as the PWB size, number of layers and direction of airflow.

Pin	Designation	Function
1	+In	Positive Input
2	RC	Remote Control
3	-In	Negative Input
4	-Out	Negative Output
5	-Sense	Negative Remote Sense
6	PG_Sync	Power Good output OR Sync
7	+Sense	Positive Remote Sense
8	+Out	Positive Output
9	CTRL	PMBus remote control OR Current Share
10	DGND	PMBus GND
11	SDA	PMBus Data
12	SALERT	PMBus Alert signal
13	SCL	PMBus Clock
14	SA1_Sync	Address pin 1 OR Sync
15	SA0	Address pin 0
16	Case	Case to GND (optional)

**BMR458 series Fully regulated DC/DC Converters**  
 Input 36-75 V, Output up to 50 A / 600 W

1/28701-BMR458 0032 revA July 2018

© Flex

**Mechanical Information - Hole Mount, Open Frame Version**

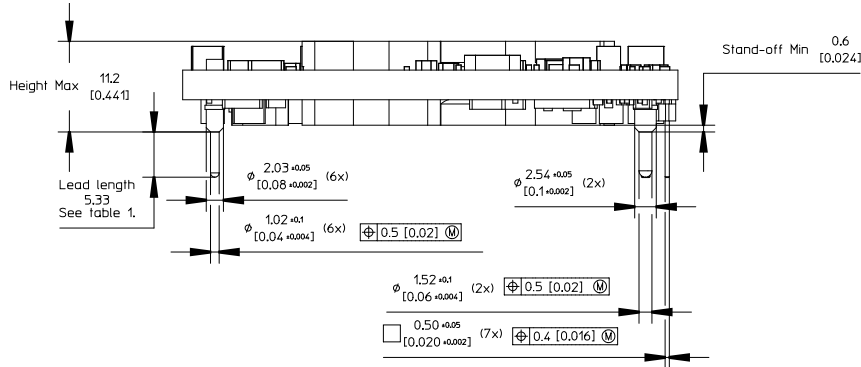

TOP VIEW

Pin positions according to recommended footprint

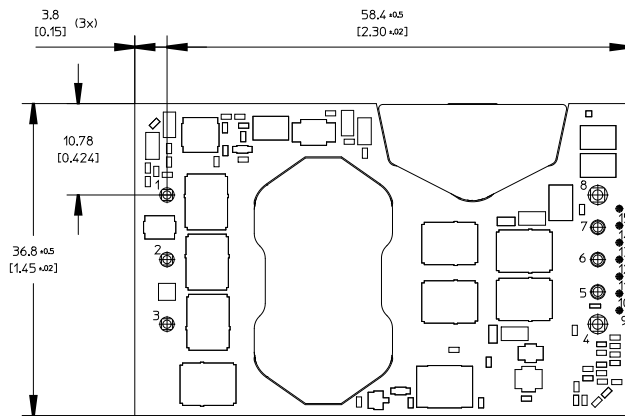

RECOMMENDED FOOTPRINT - TOP VIEW

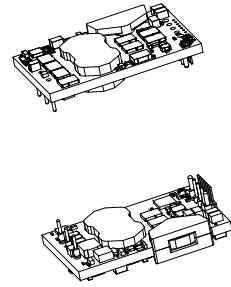

	Lead length
Standard	5.33 [0.210]
LA	3.69 [0.145]
LB	4.57 [0.180]
LC	2.79 [0.110]

Table 1.

PIN SPECIFICATIONS	
Pin 1-8 Material:	Copper alloy
Plating:	Min Au 0.1 $\mu$ m over 1-3 $\mu$ m Ni
Pin 9-15 Material:	Brass
Plating:	Min Au 0.2 $\mu$ m over 1.3 $\mu$ m Ni

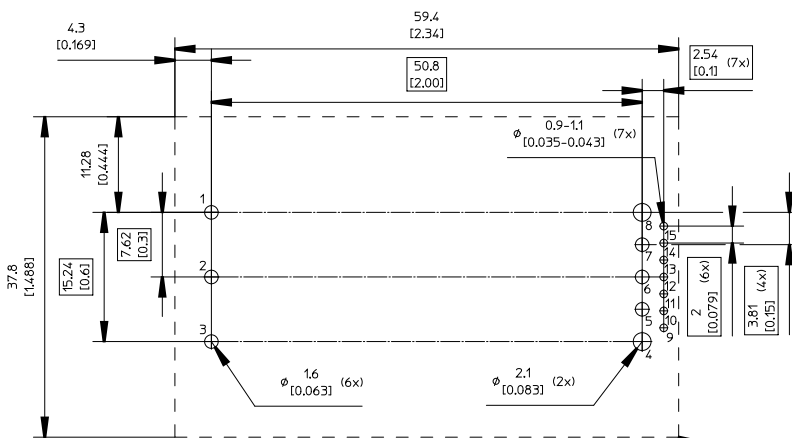

Weight: Typical 54 g  
 All dimensions in mm [inch]  
 Tolerances unless specified:  
 x.x  $\pm$ 0.50 [0.02],  
 x.xx  $\pm$ 0.25 [0.01]  
 (not applied on footprint or typical values)

Recommended keep away area for user components  
 The stand-off in combination with insulating material ensures that requirements as per IEC/EN/UL 60950 are met and 2250 V isolation maintained even if open vias or traces are present under the DC/DC converter



**BMR458 series Fully regulated DC/DC Converters**  
 Input 36-75 V, Output up to 50 A / 600 W

1/28701-BMR458 0032 revA July 2018  
 © Flex

**Mechanical Information - Hole Mount, Base Plate Version**

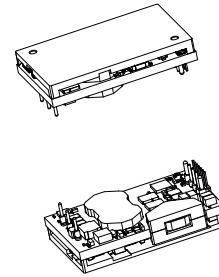
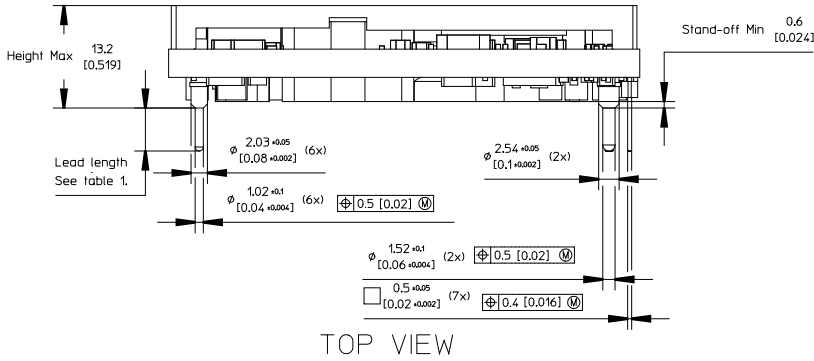

Pin positions according to recommended footprint

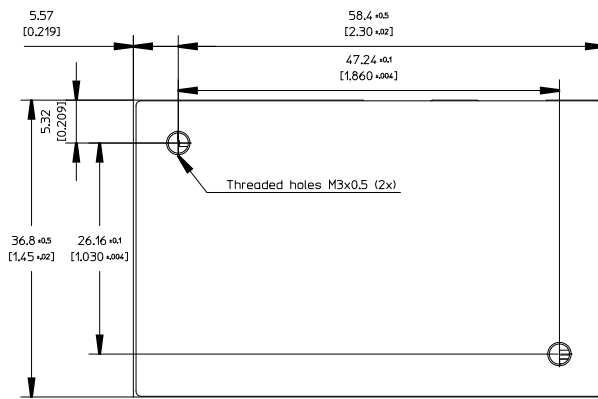

	Lead length
Standard	5.33 [0.210]
LA	3.69 [0.145]
LB	4.57 [0.180]
LC	2.79 [0.110]

Table 1.

**CASE**  
 Material: Aluminium  
 For screw attachment apply mounting torque of max 0.44 Nm [3.9 lbf in]. M3 screw must not protrude more than 2.45 mm [0.096] into the base plate.

**PIN SPECIFICATIONS**  
 Pin 1-8 Material: Copper alloy  
 Plating: Min Au 0.1 µm over 1-3 µm Ni.  
 Pin 9-15 Material: Brass  
 Plating: Min Au 0.2 µm over 1.3 µm Ni.

**RECOMMENDED FOOTPRINT - TOP VIEW**

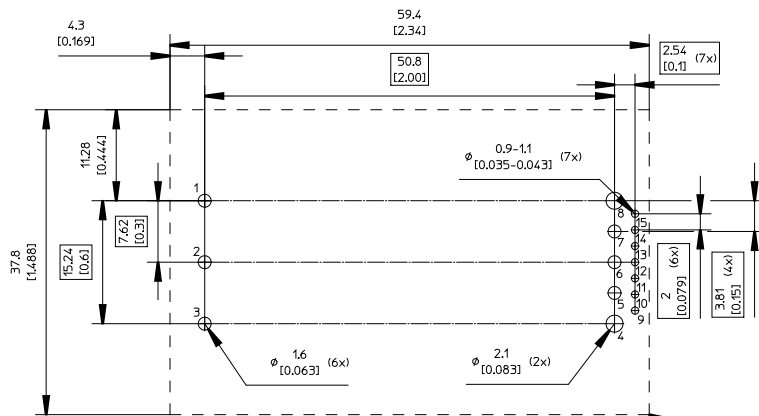

Weight: Typical 70 g  
 All dimensions in mm [inch]  
 Tolerances unless specified:  
 x.x ±0.50 [0.02],  
 x.xx±0.25 [0.01]  
 (not applied on footprint or typical values)

Recommended keep away area for user components  
 The stand-off in combination with insulating material ensures that requirements as per IEC/EN/UL 60950 are met and 2250 V isolation maintained even if open vias or traces are present under the DC/DC converter



**BMR458 series Fully regulated DC/DC Converters**  
 Input 36-75 V, Output up to 50 A / 600 W

1/28701-BMR458 0032 revA July 2018  
 © Flex

**Soldering Information – Hole Mount through Pin in Paste Assembly**

The pin in paste mount product is intended for forced convection or vapor phase reflow soldering in SnPb and Pb-free processes.

The reflow profile should be optimised to avoid excessive heating of the product. It is recommended to have a sufficiently extended preheat time to ensure an even temperature across the host PWB and it is also recommended to minimize the time in reflow.

A no-clean flux is recommended to avoid entrapment of cleaning fluids in cavities inside the product or between the product and the host board, since cleaning residues may affect long time reliability and isolation voltage.

General reflow process specifications		SnPb eutectic	Pb-free
Average ramp-up ( $T_{PRODUCT}$ )		3°C/s max	3°C/s max
Typical solder melting (liquidus) temperature	$T_L$	183°C	221°C
Minimum reflow time above $T_L$		60 s	60 s
Minimum pin temperature	$T_{PIN}$	210°C	235°C
Peak product temperature	$T_{PRODUCT}$	225°C	260°C
Average ramp-down ( $T_{PRODUCT}$ )		6°C/s max	6°C/s max
Maximum time 25°C to peak		6 minutes	8 minutes

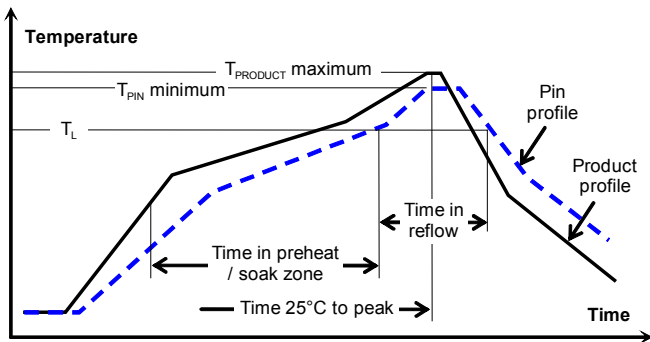

**Minimum Pin Temperature Recommendations**

Pin number 5 is chosen as reference location for the minimum pin temperature recommendation since this will likely be the coolest solder joint during the reflow process.

**SnPb solder processes**

For SnPb solder processes, a pin temperature ( $T_{PIN}$ ) in excess of the solder melting temperature, ( $T_L$ , 183°C for Sn63Pb37) for more than 60 seconds and a peak temperature of 220°C is recommended to ensure a reliable solder joint.

For dry packed products only: depending on the type of solder paste and flux system used on the host board, up to a recommended maximum temperature of 245°C could be used, if the products are kept in a controlled environment (dry pack handling and storage) prior to assembly.

**Lead-free (Pb-free) solder processes**

For Pb-free solder processes, a pin temperature ( $T_{PIN}$ ) in excess of the solder melting temperature ( $T_L$ , 217 to 221°C for SnAgCu solder alloys) for more than 60 seconds and a peak temperature of 245°C on all solder joints is recommended to ensure a reliable solder joint.

**Maximum Product Temperature Requirements**

Top of the product PWB near pin 2 is chosen as reference location for the maximum (peak) allowed product temperature ( $T_{PRODUCT}$ ) since this will likely be the warmest part of the product during the reflow process.

**SnPb solder processes**

For SnPb solder processes, the product is qualified for MSL 1 according to IPC/JEDEC standard J-STD-020C.

During reflow  $T_{PRODUCT}$  must not exceed 225 °C at any time.

**Pb-free solder processes**

For Pb-free solder processes, the product is qualified for MSL 3 according to IPC/JEDEC standard J-STD-020C.

During reflow  $T_{PRODUCT}$  must not exceed 260 °C at any time.

**Dry Pack Information**

Products intended for Pb-free reflow soldering processes are delivered in standard moisture barrier bags according to IPC/JEDEC standard J-STD-033 (Handling, packing, shipping and use of moisture/reflow sensitivity surface mount devices).

Using products in high temperature Pb-free soldering processes requires drypack storage and handling. In case the products have been stored in an uncontrolled environment and no longer can be considered dry, the modules must be baked according to J-STD-033.

**Thermocoupler Attachment**

Top of PWB near pin 2 for measurement of maximum product temperature,  $T_{PRODUCT}$

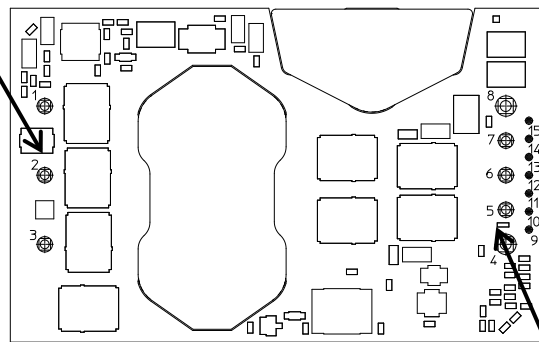

Pin 5 for measurement of minimum pin (solder joint) temperature,  $T_{PIN}$

**BMR458 series** Fully regulated DC/DC Converters  
 Input 36-75 V, Output up to 50 A / 600 W

1/28701-BMR458 0032 revA

July 2018

© Flex

### Soldering Information - Hole Mounting

The hole mounted product is intended for plated through hole mounting by wave or manual soldering. The pin temperature is specified to maximum to 270°C for maximum 10 seconds.

A maximum preheat rate of 4°C/s and maximum preheat temperature of 150°C is suggested. When soldering by hand, care should be taken to avoid direct contact between the hot soldering iron tip and the pins for more than a few seconds in order to prevent overheating.

A no-clean flux is recommended to avoid entrapment of cleaning fluids in cavities inside the product or between the product and the host board. The cleaning residues may affect long time reliability and isolation voltage.

### Delivery Package Information

The products are delivered in antistatic polystyrene trays and in antistatic PE foam trays.

Tray Specifications – Through hole pin in paste & base plate version (both dry pack)	
<b>Material</b>	Antistatic Polystyrene (black)
<b>Surface resistance</b>	$10^9 < \text{Ohm/square} < 10^{11}$
<b>Bakability</b>	The trays cannot be baked
<b>Tray thickness</b>	25.8 mm 1.02 [inch] (TH PIP version) 25 mm 0.984 [inch] (Base plate version)
<b>Box capacity</b>	48 products (4 full trays/box)
<b>Tray weight</b>	56 g empty, 704 g full tray (TH PIP) 58 g empty, 898 g full tray (Base plate)

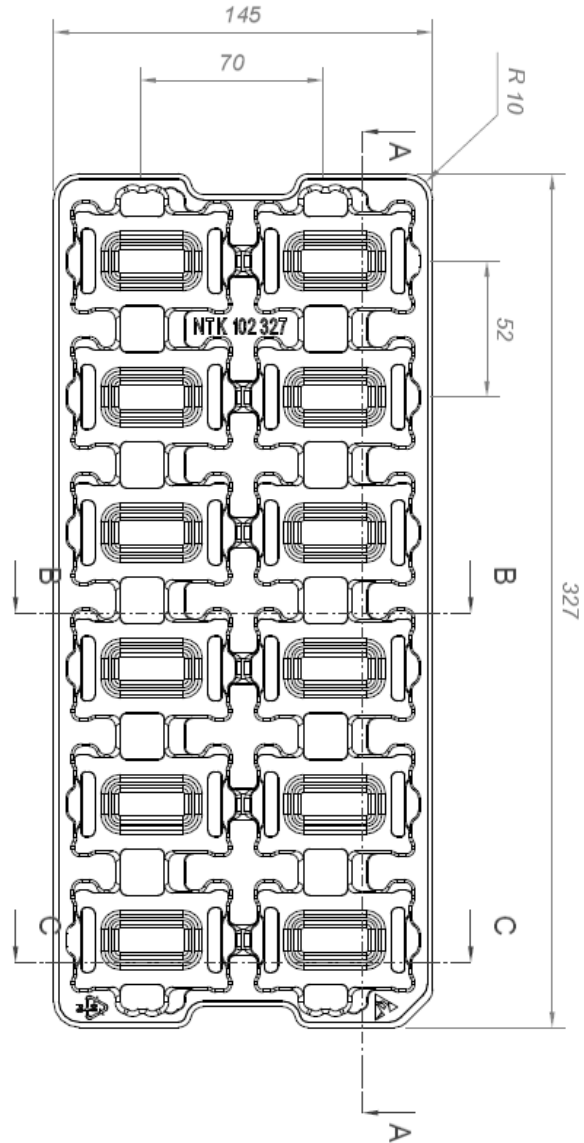

JEDEC standard tray for 2x6 = 12 products.

All dimensions in mm

Tolerances: X.x ±0.26 [0.01], X.xx ±0.13 [0.005]

Note: pick up positions refer to center of pocket.

See mechanical drawing for exact location on product.

**BMR458 series** Fully regulated DC/DC Converters  
 Input 36-75 V, Output up to 50 A / 600 W

1/28701-BMR458 0032 revA July 2018

© Flex

**Tray Specifications – Through hole version without dry pack**

<b>Material</b>	PE Foam
<b>Surface resistance</b>	$10^5 < \text{Ohm/square} < 10^{11}$
<b>Bakability</b>	The trays are not bakeable
<b>Tray capacity</b>	20 converters/tray
<b>Box capacity</b>	60 products (3 full trays/box)
<b>Weight</b>	Product – Open frame 1100 g full tray, 140g empty tray Product – Base plate option 1480 g full tray, 140 g empty tray

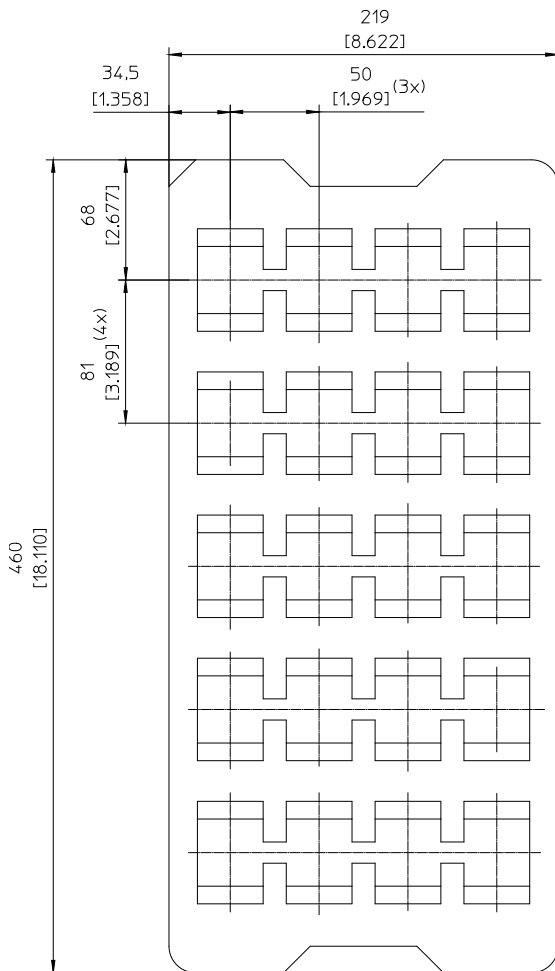

**BMR458 series** Fully regulated DC/DC Converters  
 Input 36-75 V, Output up to 50 A / 600 W

1/28701-BMR458 0032 revA July 2018

© Flex

**Product Qualification Specification**

Characteristics			
External visual inspection	IPC-A-610		
Change of temperature (Temperature cycling)	IEC 60068-2-14 Na	Temperature range Number of cycles Dwell/transfer time	-40 to 100°C 1000 15 min/0-1 min
Cold (in operation)	IEC 60068-2-1 Ad	Temperature T <sub>A</sub> Duration	-45°C 72 h
Damp heat	IEC 60068-2-67 Cy	Temperature Humidity Duration	85°C 85 % RH 1000 hours
Dry heat	IEC 60068-2-2 Bd	Temperature Duration	125°C 1000 h
Electrostatic discharge susceptibility	IEC 61340-3-1, JESD 22-A114 IEC 61340-3-2, JESD 22-A115	Human body model (HBM) Machine Model (MM)	Class 2, 2000 V Class 3, 200 V
Immersion in cleaning solvents	IEC 60068-2-45 XA, method 2	Water Glycol ether Isopropyl alcohol	55°C 35°C 35°C
Mechanical shock	IEC 60068-2-27 Ea	Peak acceleration Duration	100 g 6 ms
Moisture reflow sensitivity <sup>1</sup>	J-STD-020E	Level 1 (SnPb-eutectic) Level 3 (Pb Free)	225°C 260°C
Operational life test	MIL-STD-202G, method 108A	Duration	1000 h
Resistance to soldering heat <sup>2</sup>	IEC 60068-2-20 Tb, method 1A	Solder temperature Duration	270°C 10-13 s
Robustness of terminations	IEC 60068-2-21 Test Ua1 IEC 60068-2-21 Test Ue1	Through hole mount products Surface mount products	All leads All leads
Solderability	IEC 60068-2-58 test Td <sup>1</sup>	Preconditioning Temperature, SnPb Eutectic Temperature, Pb-free	150°C dry bake 16 h 215°C 235°C
	IEC 60068-2-20 test Ta <sup>2</sup>	Preconditioning Temperature, SnPb Eutectic Temperature, Pb-free	Steam ageing 235°C 245°C
Vibration, broad band random	IEC 60068-2-64 Fh, method 1	Frequency Spectral density Duration	10 to 500 Hz 0.07 g <sup>2</sup> /Hz 10 min in each direction

**Notes**
<sup>1</sup> Only for products intended for reflow soldering (surface mount products)

<sup>2</sup> Only for products intended for wave soldering (plated through hole products)

<b>BMR458 series</b> Fully regulated DC/DC Converters Input 36-75 V, Output up to 50 A / 600 W	1/28701-BMR458 0032 revA July 2018
	© Flex

## Appendix - PMBus Commands

This appendix contains a detailed reference of the PMBus commands supported by the product.

### Data Formats

The products make use of a few standardized numerical formats, along with custom data formats. A detailed walkthrough of the above formats is provided in AN304, as well as in sections 7 and 8 of the PMBus Specification Part II. The custom data formats vary depending on the command, and are detailed in the command description.

### Standard Commands

The functionality of commands with code 0x00 to 0xCF is usually based on the corresponding command specification provided in the PMBus Standard Specification Part II (see Power System Management Bus Protocol Documents below). However there might be different interpretations of the PMBus Standard Specification or only parts of the Standard Specification applied, thus the detailed command description below should always be consulted.

### Forum Websites

The System Management Interface Forum (SMIF)

<http://www.powersig.org/>

The System Management Interface Forum (SMIF) supports the rapid advancement of an efficient and compatible technology base that promotes power management and systems technology implementations. The SMIF provides a membership path for any company or individual to be active participants in any or all of the various working groups established by the implementer forums.

Power Management Bus Implementers Forum (PMBUS-IF)

<http://pmbus.org/>

The PMBus-IF supports the advancement and early adoption of the PMBus protocol for power management. This website offers recent PMBus specification documents, PMBus articles, as well as upcoming PMBus presentations and seminars, PMBus Document Review Board (DRB) meeting notes, and other PMBus related news.

### PMBus – Power System Management Bus Protocol Documents

These specification documents may be obtained from the PMBus-IF website described above. These are required reading for complete understanding of the PMBus implementation. This appendix will not re-address all of the details contained within the two PMBus Specification documents.

Specification Part I – General Requirements Transport And Electrical Interface

Includes the general requirements, defines the transport and electrical interface and timing requirements of hard wired signals.

Specification Part II – Command Language

Describes the operation of commands, data formats, fault management and defines the command language used with the PMBus.

### SMBus – System Management Bus Documents

System Management Bus Specification, Version 2.0, August 3, 2000

This specification specifies the version of the SMBus on which Revision 1.2 of the PMBus Specification is based. This specification is freely available from the System Management Interface Forum Web site at:

<http://www.smbus.org/specs/>



**BMR458 series** Fully regulated DC/DC Converters  
Input 36-75 V, Output up to 50 A / 600 W

1/28701-BMR458 0032 revA

July 2018

© Flex

### PMBus Command Summary and Factory Default Values of Standard Configuration

The factory default values provided in the table below are valid for the Standard configuration. Factory default values for other configurations can be found using the Ericsson Power Designer tool.

Code	Name	Data Format	Factory Default Value Standard Configuration BMR 458 XXXX/003 R1	
0x01	OPERATION	R/W Byte	0x84	
0x02	ON_OFF_CONFIG	R/W Byte	0x18	
0x03	CLEAR_FAULTS	Send Byte		
0x10	WRITE_PROTECT	R/W Byte		
0x11	STORE_DEFAULT_ALL	Send Byte		
0x12	RESTORE_DEFAULT_ALL	Send Byte		
0x15	STORE_USER_ALL	Send Byte		
0x16	RESTORE_USER_ALL	Send Byte		
0x19	CAPABILITY	Read Byte		
0x20	VOUT_MODE	Read Byte	0x15	
0x21	VOUT_COMMAND	R/W Word	0x6000	12.0 V
0x22	VOUT_TRIM	R/W Word	0x0000	0.0 V
0x23	VOUT_CAL_OFFSET	R/W Word	Unit Specific	
0x24	VOUT_MAX	R/W Word	0x7333	14.4 V
0x25	VOUT_MARGIN_HIGH	R/W Word	0x699A	13.2 V
0x26	VOUT_MARGIN_LOW	R/W Word	0x5666	10.8 V
0x27	VOUT_TRANSITION_RATE	R/W Word	0x9B02	0.1 V/ms
0x28	VOUT_DROOP	R/W Word	0xE800	0.0 mV/A
0x29	VOUT_SCALE_LOOP	R/W Word	Unit Specific	
0x2A	VOUT_SCALE_MONITOR	R/W Word	Unit Specific	
0x32	MAX_DUTY	R/W Word	0xEB18	99.0 %
0x33	FREQUENCY_SWITCH	R/W Word	0x00B4	180.0 kHz
0x35	VIN_ON	R/W Word	0x0023	35.0 V
0x36	VIN_OFF	R/W Word	0x0021	33.0 V
0x37	INTERLEAVE	R/W Word	0x0021	
0x39	IOUT_CAL_OFFSET	Read Word	Unit Specific	
0x40	VOUT_OV_FAULT_LIMIT	R/W Word	0x7CCD	15.6 V
0x41	VOUT_OV_FAULT_RESPONSE	R/W Byte	0xC0	
0x42	VOUT_OV_WARN_LIMIT	R/W Word	0x7800	15.0 V
0x43	VOUT_UV_WARN_LIMIT	R/W Word	0x0000	0.0 V
0x44	VOUT_UV_FAULT_LIMIT	R/W Word	0x0000	0.0 V
0x45	VOUT_UV_FAULT_RESPONSE	R/W Byte	0x00	
0x46	IOUT_OC_FAULT_LIMIT	R/W Word	0x003A	58.0 A
0x47	IOUT_OC_FAULT_RESPONSE	R/W Byte	0x7B	
0x48	IOUT_OC_LV_FAULT_LIMIT	R/W Word	0x1CCC	3.6 V
0x4A	IOUT_OC_WARN_LIMIT	R/W Word	0x003A	58.0 A
0x4F	OT_FAULT_LIMIT	R/W Word	0x007D	125.0 °C
0x50	OT_FAULT_RESPONSE	R/W Byte	0xC0	
0x51	OT_WARN_LIMIT	R/W Word	0x005A	90.0 °C
0x52	UT_WARN_LIMIT	R/W Word	0xE580	-40.0 °C
0x53	UT_FAULT_LIMIT	R/W Word	0xE4E0	-50.0 °C
0x54	UT_FAULT_RESPONSE	R/W Byte	0x00	
0x55	VIN_OV_FAULT_LIMIT	R/W Word	0xEAA8	85.0 V
0x56	VIN_OV_FAULT_RESPONSE	R/W Byte	0xC0	
0x57	VIN_OV_WARN_LIMIT	R/W Word	0xEA80	80.0 V
0x58	VIN_UV_WARN_LIMIT	R/W Word	0x0000	0.0 V
0x59	VIN_UV_FAULT_LIMIT	R/W Word	0x0000	0.0 V
0x5A	VIN_UV_FAULT_RESPONSE	R/W Byte	0x00	
0x5E	POWER_GOOD_ON	R/W Word	0x4000	8.0 V
0x5F	POWER_GOOD_OFF	R/W Word	0x2800	5.0 V
0x60	TON_DELAY	R/W Word	0x0000	
0x61	TON_RISE	R/W Word	0x000A	
0x62	TON_MAX_FAULT_LIMIT	R/W Word	0x000F	
0x63	TON_MAX_FAULT_RESPONSE	R/W Byte	0x00	
0x64	TOFF_DELAY	R/W Word	0x0005	

**BMR458 series** Fully regulated DC/DC Converters  
 Input 36-75 V, Output up to 50 A / 600 W

1/28701-BMR458 0032 revA

July 2018

© Flex

Code	Name	Data Format	Factory Default Value Standard Configuration BMR 458 XXXX/003 R1	
0x65	TOFF_FALL	R/W Word	0x000A	
0x66	TOFF_MAX_WARN_LIMIT	R/W Word	0x000F	
0x78	STATUS_BYTE	Read Byte		
0x79	STATUS_WORD	Read Word		
0x7A	STATUS_VOUT	Read Byte		
0x7B	STATUS_IOUT	Read Byte		
0x7C	STATUS_INPUT	Read Byte		
0x7D	STATUS_TEMPERATURE	Read Byte		
0x7E	STATUS_CML	Read Byte		
0x88	READ_VIN	Read Word		
0x8B	READ_VOUT	Read Word		
0x8C	READ_IOUT	Read Word		
0x8D	READ_TEMPERATURE_1	Read Word		
0x8E	READ_TEMPERATURE_2	Read Word		
0x94	READ_DUTY_CYCLE	Read Word		
0x95	READ_FREQUENCY	Read Word		
0x98	PMBUS_REVISION	Read Byte		
0x99	MFR_ID	R/W Block (12)	Unit Specific	
0x9A	MFR_MODEL	R/W Block (20)	Unit Specific	
0x9B	MFR_REVISION	R/W Block (12)	Unit Specific	
0x9C	MFR_LOCATION	R/W Block (12)	Unit Specific	
0x9D	MFR_DATE	R/W Block (12)	Unit Specific	
0x9E	MFR_SERIAL	R/W Block (20)	Unit Specific	
0xB0	USER_DATA_00	R/W Block (16)	Unit Specific	
0xD0	MFR_PGOOD_POLARITY	R/W Byte	0x00	
0xD1	MFR_FAST_OCP_CFG	R/W Word	0x02E0	96 level, 2 samples
0xD2	MFR_RESPONSE_UNIT_CFG	R/W Byte	0x55	
0xD3	MFR_VIN_SCALE_MONITOR	Read Block (4)	Unit Specific	
0xD4	MFR_PREBIAS_DVDT_CFG	R/W Block (8)	0x1E001E00F0040401	
0xD5	MFR_FILTER_SELECT	R/W Byte	0x00	
0xD7	MFR_GET_SNAPSHOT	Read Block (32)		
0xD8	MFR_TEMP_COMPENSATION	Read Block (8)	0x009590008580007F	
0xD9	MFR_SET_ROM_MODE	Write Block (4)		
0xDA	MFR_ISHARE_THRESHOLD	R/W Block (8)	0x0000000000000000	
0xDB	MFR_GET_RAMP_DATA	Read Block (32)		
0xDC	MFR_SELECT_TEMPERATURE_SENSOR	R/W Byte	0x01	
0xDD	MFR_VIN_OFFSET	Read Block (4)	Unit Specific	
0xDE	MFR_VOUT_OFFSET_MONITOR	Read Word	Unit Specific	
0xDF	MFR_GET_STATUS_DATA	Read Block (32)		
0xE0	MFR_SPECIAL_OPTIONS	R/W Byte	0x00	
0xE1	MFR_TEMP_OFFSET_INT	Read Word	Unit Specific	
0xE2	MFR_REMOTE_TEMP_CAL	Read Block (4)	Unit Specific	
0xE3	MFR_REMOTE_CTRL	R/W Byte	0x15	
0xE6	MFR_VFF_PARAMS	R/W Block (4)	0x0E010801	
0xE7	MFR_TEMP_COEFF	Read Block (6)	0x00FF00FFFC00	
0xE8	MFR_FILTER_COEFF	R/W Block (27)	0x01B60267FF000000005503550300000050001800000058023501	
0xE9	MFR_FILTER_NLR_GAIN	R/W Block (16)	0x09000000000000000000000000000000F00	
0xEB	MFR_MIN_DUTY	R/W Word	0x4C46	70 ns, 76 ns
0xEC	MFR_ACTIVE_CLAMP	Read Word	0x0917	23 x4 ns, 9 x4 ns
0xEE	MFR_OFFSET_ADDRESS	R/W Byte	0x00	0 n + SA0
0xEF	MFR_DBV_CONFIG	R/W Block (6)	0x4C482A0E0A24	
0xF0	MFR_DEBUG_BUFF	R/W Block (8)		
0xF1	MFR_SETUP_PASSWORD	R/W Block (12)		
0xF2	MFR_DISABLE_SECURITY_ONCE	R/W Block (6)		
0xF4	MFR_SECURITY_BIT_MASK	Read Block (32)		
0xF5	MFR_TRANSFORMER_TURN	Read Byte	0x52	
0xF6	MFR_OSC_TRIM	Read Byte	0x00	

**BMR458 series** Fully regulated DC/DC Converters  
Input 36-75 V, Output up to 50 A / 600 W

1/28701-BMR458 0032 revA July 2018

© Flex

Code	Name	Data Format	Factory Default Value Standard Configuration BMR 458 XXXX/003 R1	
0xF7	MFR_DLC_CONFIG	R/W Block (8)	0x0000000000000000	
0xF8	MFR_ILIM_SOFTSTART	R/W Byte	0x14	20 %
0xF9	MFR_MULTI_PIN_CONFIG	R/W Byte	0x04	
0xFC	MFR_ADDED_DROOP_DURING_RAMP	R/W Word	0xE800	0.0 mV/A
0xFD	MFR_FIRMWARE_DATA	Read Block (20)		
0xFE	MFR_RESTART	Write Block (4)		

**BMR458 series** Fully regulated DC/DC Converters  
Input 36-75 V, Output up to 50 A / 600 W

1/28701-BMR458 0032 revA July 2018

© Flex

## PMBus Command Details

### OPERATION (0x01)

Transfer Type: R/W Byte

Description: Sets the desired PMBus enable and margin operations.

Bit	Function	Description	Value	Function	Description
7:6	Enable	Make the device enable or disable.	00	Immediate Off	Disable Immediately without sequencing.
			01	Soft Off	Disable "Softly" with sequencing.
			10	Enable	Enable device to the desired margin state.
5:4	Margin	Select between margin high/low states or nominal output.	00	Nominal	Operate at nominal output voltage.
			01	Margin Low	Operate at margin low voltage set in VOUT_MARGIN_LOW.
			10	Margin High	Operate at margin high voltage set in VOUT_MARGIN_HIGH.
3:2	Act on Fault	Set 10b to act on fault or set to 01b to ignore fault.	01	Ignore Faults	Ignore Faults when in a margined state. The device will ignore appropriate overvoltage/undervoltage warnings and faults and respond as programmed by the warning limit or fault response command.
			10	Act on Faults	Act on Faults when in a margined state. The device will handle appropriate overvoltage/undervoltage warnings and faults and respond as programmed by the warning limit or fault response command.

### ON\_OFF\_CONFIG (0x02)

Transfer Type: R/W Byte

Description: Configures how the device is controlled by the CONTROL pin and the PMBus.

Bit	Function	Description	Value	Function	Description
4	Powerup Operation	Sets the default to either operate any time power is present or for the on/off to be controlled by CONTROL pin and serial bus commands.	0	Enable Always	Unit powers up any time power is present regardless of state of the CONTROL pin.
			1	Enable pin or PMBus	Unit does not power up until commanded by the CONTROL pin and OPERATION command.
3	PMBus Enable Mode	Controls how the unit responds to commands received via the serial bus.	0	Ignore PMBus	Unit ignores the on/off portion of the OPERATION command from serial bus.
			1	Use PMBus	To start, the unit requires that the on/off portion of the OPERATION command is instructing the unit to run.
2	Enable Pin Mode	Controls how the unit responds to the CONTROL pin.	0	Ignore pin	Unit ignores the CONTROL/Enable pin.
			1	Use pin	Unit requires the CONTROL pin to be asserted to start the unit.
1	Enable Pin Polarity	Polarity of the CONTROL pin.	0	Active Low	Enable pin will cause device to enable when driven low.
			1	Active High	Enable pin will cause device to enable when driven high.
0	Disable Action	CONTROL pin action when commanding the unit to turn off.	0	Soft Off	Use the programmed turn off delay and fall time.

**BMR458 series Fully regulated DC/DC Converters**  
 Input 36-75 V, Output up to 50 A / 600 W

1/28701-BMR458 0032 revA July 2018

© Flex

Bit	Function	Description	Value	Function	Description
			1	Imm. Off	Turn off the output and stop transferring energy to the output as fast as possible. The device's product literature shall specify whether or not the device sinks current to decrease the output voltage fall time.

**CLEAR\_FAULTS (0x03)**

Transfer Type: Send Byte

Description: Clears all fault status bits

**WRITE\_PROTECT (0x10)**

Transfer Type: R/W Byte

Description: The WRITE\_PROTECT command is used to control writing to the PMBus device. The intent of this command is to provide protection against accidental changes. This command is not intended to provide protection against deliberate or malicious changes to a device's configuration or operation.

Bit	Description	Value	Function	Description
7:0	All supported commands may have their parameters read, regardless of the WRITE_PROTECT settings.	0x80	Disable all writes	Disable all writes except to the WRITE_PROTECT command.
		0x40	Enable operation	Disable all writes except to the WRITE_PROTECT, OPERATION and PAGE commands.
		0x20	Enable control and Vout commands	Disable all writes except to the WRITE_PROTECT, OPERATION, PAGE, ON_OFF_CONFIG and VOUT_COMMAND commands.
		0x00	Enable all commands	Enable writes to all commands.

**STORE\_DEFAULT\_ALL (0x11)**

Transfer Type: Send Byte

Description: Commands the device to store its configuration into the Default Store.

**RESTORE\_DEFAULT\_ALL (0x12)**

Transfer Type: Send Byte

Description: Commands the device to restore its configuration from the Default Store.

**STORE\_USER\_ALL (0x15)**

Transfer Type: Send Byte

Description: Stores, at the USER level, all PMBus values that were changed since the last restore command.

**RESTORE\_USER\_ALL (0x16)**

Transfer Type: Send Byte

Description: Restores PMBus settings that were stored using STORE\_USER\_ALL. This command is automatically performed at power up.

**CAPABILITY (0x19)**

Transfer Type: Read Byte

Description: This command provides a way for a host system to determine some key capabilities of a PMBus device.

Bit	Function	Description	Value	Function	Description
7	Packet Error Checking	Packet error checking.	00	Not supported	Packet Error Checking not supported.
			01	Supported	Packet Error Checking is supported.
6:5	Maximum Bus Speed	Maximum bus speed.	00	100kHz	Maximum supported bus speed is 100 kHz.

**BMR458 series Fully regulated DC/DC Converters**  
 Input 36-75 V, Output up to 50 A / 600 W

1/28701-BMR458 0032 revA July 2018

© Flex

Bit	Function	Description	Value	Function	Description
			01	400kHz	Maximum supported bus speed is 400 kHz.
3:0	Smbalert	SMBALERT	00	No Smbalert	The device does not have a SMBALERT# pin and does not support the SMBus Alert Response protocol.
			01	Have Smbalert	The device does have a SMBALERT# pin and does support the SMBus Alert Response protocol.

**VOUT\_MODE (0x20)**

Transfer Type: Read Byte

Description: Controls how future VOUT-related commands parameters will be interpreted.

Bit	Function	Description	Format
4:0		Five bit two's complement EXPONENT for the MANTISSA delivered as the data bytes for VOUT_COMMAND in VOUT_LINEAR Mode, five bit VID code identifier per in VID Mode or always set to 00000b in Direct Mode.	Integer Signed

Bit	Function	Description	Value	Function	Description
7:5		Set to 000b to select VOUT_LINEAR Mode (Five bit two's complement exponent for the MANTISSA delivered as the data bytes for an output voltage related command), set to 001b to select VID Mode (Five bit VID code identifier per) or set to 010b to select Direct Mode (Always set to 00000b).	000	Linear	Linear Mode Format.
			001	VID	VID Mode.
			010	Direct	Direct Mode.

**VOUT\_COMMAND (0x21)**

Transfer Type: R/W Word

Description: Commands the device to transition to a new output voltage.

Bit	Description	Format	Unit
15:0	Sets the nominal value of the output voltage.	Vout Mode Unsigned	V

**VOUT\_TRIM (0x22)**

Transfer Type: R/W Word

Description: Configures a fixed offset to be applied to the output voltage when enabled.

Bit	Description	Format	Unit
15:0	Sets VOUT trim value. The two bytes are formatted as a two's complement binary mantissa, used in conjunction with the exponent set in VOUT_MODE.	Vout Mode Signed	V

**VOUT\_CAL\_OFFSET (0x23)**

Transfer Type: R/W Word

Description: Vout calibration value. It is a signed number in Vout linear mode. The setting will be applied output voltage.

Bit	Description	Format	Unit
15:0	Vout calibration value. It is a signed number in Vout linear mode. The setting will be applied output voltage.	Vout Mode Signed	V

**VOUT\_MAX (0x24)**

Transfer Type: R/W Word

Description: Configures the maximum allowed output voltage.

**BMR458 series Fully regulated DC/DC Converters**  
 Input 36-75 V, Output up to 50 A / 600 W

 1/28701-BMR458 0032 revA July 2018  
 © Flex

Bit	Description	Format	Unit
15:0	Sets the maximum possible value setting of VOUT. The maximum VOUT_MAX setting is 110% of the pin-strap setting.	Vout Mode Unsigned	V

**VOUT\_MARGIN\_HIGH (0x25)**

Transfer Type: R/W Word

Description: Configures the target for margin-up commands.

Bit	Description	Format	Unit
15:0	Sets the value of the VOUT during a margin high.	Vout Mode Unsigned	V

**VOUT\_MARGIN\_LOW (0x26)**

Transfer Type: R/W Word

Description: Configures the target for margin-down commands.

Bit	Description	Format	Unit
15:0	Sets the value of the VOUT during a margin low.	Vout Mode Unsigned	V

**VOUT\_TRANSITION\_RATE (0x27)**

Transfer Type: R/W Word

Description: Configures the transition time for margins and VCOMMAND output changes.

Bit	Description	Format	Unit
15:0	Sets the transition rate during margin or other change of VOUT.	Linear	V/ms

**VOUT\_DROOP (0x28)**

Transfer Type: R/W Word

Description: Configures the Isense voltage to load current ratio.

Bit	Description	Format	Unit
15:0	Sets the effective load line (V/I slope) for the rail in which the device is used.	Linear	mV/A

**VOUT\_SCALE\_LOOP (0x29)**

Transfer Type: R/W Word

Description: Gain of Vout EADC sense.

Bit	Description	Format
15:0	Gain of Vout EADC sense.	Direct

**VOUT\_SCALE\_MONITOR (0x2A)**

Transfer Type: R/W Word

Description: Normally there is a voltage divider in the voltage sense circuit. The scale factor is represented by VOUT\_SCALE\_MONITOR.

Bit	Description	Format
15:0	Normally there is a voltage divider in the voltage sense circuit. The scale factor is represented by VOUT_SCALE_MONITOR.	Direct

**MAX\_DUTY (0x32)**

Transfer Type: R/W Word

Description: Configures the maximum allowed duty-cycle.

Bit	Description	Format	Unit
15:0	Sets the maximum allowable duty cycle of the switching frequency.	Linear	%

**FREQUENCY\_SWITCH (0x33)**

Transfer Type: R/W Word

Description: Controls the switching frequency in 1kHz steps.

**BMR458 series Fully regulated DC/DC Converters**  
 Input 36-75 V, Output up to 50 A / 600 W

 1/28701-BMR458 0032 revA July 2018  
 © Flex

Bit	Description	Format	Unit
15:0	Sets the switching frequency.	Linear	kHz

**VIN\_ON (0x35)**

Transfer Type: R/W Word

Description: The VIN\_ON command sets the value of the input voltage, in volts, at which the unit should start power conversion.

Bit	Description	Format	Unit
15:0	Sets the VIN ON threshold.	Linear	V

**VIN\_OFF (0x36)**

Transfer Type: R/W Word

Description: The VIN\_OFF command sets the value of the input voltage, in volts, at which the unit, once operation has started, should stop power conversion.

Bit	Description	Format	Unit
15:0	Sets the VIN OFF threshold.	Linear	V

**INTERLEAVE (0x37)**

Transfer Type: R/W Word

Description: Configures the phase offset with respect to a common SYNC clock. When multiple product share a common DC input supply, spreading of the switching phases between the products can be utilized. This reduces the input capacitance requirements and efficiency losses, since the peak current drawn from the input supply is effectively spread out over the whole switch period. If two or more units have their outputs connected in parallel, interleaving will reduce ripple currents. This requires that the products are synchronized using the SYNC pin.

Bit	Function	Description	Format
11:8	Group ID Number	Value 0-15. Sets an ID number to a group of interleaved rails.	Integer Unsigned
7:4	Number of Rails	Value 0-15. Sets the number of units in the group, including the SYNC OUT product.	Integer Unsigned
3:0	Rail Position	Value 0-15. Sets the interleave order for this unit. The product configured to SYNC OUT shall be assigned to number 0	Integer Unsigned

**IOUT\_CAL\_OFFSET (0x39)**

Transfer Type: Read Word

Description: Sets the current-sense offset.

Bit	Description	Format	Unit
15:0	Sets an offset to IOUT readings. Use to compensate for delayed measurements of current ramp.	Linear	A

**VOUT\_OV\_FAULT\_LIMIT (0x40)**

Transfer Type: R/W Word

Description: Output over voltage fault limit.

Bit	Description	Format	Unit
15:0	Output over voltage fault limit.	Vout Mode Unsigned	V

**VOUT\_OV\_FAULT\_RESPONSE (0x41)**

Transfer Type: R/W Byte

Description: Output over voltage fault response.

Bit	Function	Description	Value	Function	Description
7:6	Response		00	Ignore Fault	The PMBus device continues operation without interruption.



**BMR458 series** Fully regulated DC/DC Converters  
Input 36-75 V, Output up to 50 A / 600 W

1/28701-BMR458 0032 revA

July 2018

© Flex

Bit	Function	Description	Value	Function	Description
		Describes the device interruption operation. 00b - The PMBus device continues operation without interruption. 01b - The PMBus device continues operation for the delay time specified by bits [2:0] and the delay time unit specified for that particular fault. If the fault condition is still present at the end of the delay time, the unit responds as programmed in the Retry Setting (bits [5:3]). 10b - The device shuts down (disables the output) and responds according to the Retry Setting in bits [5:3]. 11b - The device's output is disabled while the fault is present. Operation resumes and the output is enabled when the fault condition no longer exists.	01	Perform Retries while Operating	The PMBus device continues operation for the delay time specified by bits [2:0] and the delay time unit specified for that particular fault. If the fault condition is still present at the end of the delay time, the unit responds as programmed in the Retry Setting (bits [5:3]).
			10	Disable and retry	The device shuts down (disables the output) and responds according to the retry setting in bits [5:3].
			11	Disable until Fault Cleared	A fault can be cleared in several ways: The bit is individually cleared, The device receives a CLEAR_FAULTS command, a RESET signal (if one exists) is asserted, the output is commanded through the CTRL pin, the OPERATION command, or the combined action of the CTRL pin and OPERATION command, to turn off and then to turn back on, or Bias power is removed from the PMBus device.
5:3	Retries	The device attempts to restart the number of times set by these bits. 000b means the device does not attempt a restart. 111b means the device attempts restarting continuously.	000	Do Not Retry	A zero value for the Retry Setting means that the unit does not attempt to restart. The output remains disabled until the fault is cleared (Section 10.7).
			001	Retry Once	The PMBus device attempts to restart 1 time. If the device fails to restart, it disables the output and remains off until the fault is cleared as described in Section 10.7. The time between the start of each attempt to restart is set by the value in bits [2:] along with the delay time unit specified for that particular fault.
			010	Retry Twice	The PMBus device attempts to restart 2 times. If the device fails to restart, it disables the output and remains off until the fault is cleared as described in Section 10.7. The time between the start of each attempt to restart is set by the value in bits [2:] along with the delay time unit specified for that particular fault.
			011	Retry 3 times	The PMBus device attempts to restart 3 times. If the device fails to restart, it disables the output and remains off until the fault is cleared as described in Section 10.7. The time between the start of each attempt to restart is set by the value in bits [2:] along with the delay time unit specified for that particular fault.

**BMR458 series** Fully regulated DC/DC Converters  
Input 36-75 V, Output up to 50 A / 600 W

1/28701-BMR458 0032 revA

July 2018

© Flex

Bit	Function	Description	Value	Function	Description
			100	Retry 4 times	The PMBus device attempts to restart 4 times. If the device fails to restart, it disables the output and remains off until the fault is cleared as described in Section 10.7. The time between the start of each attempt to restart is set by the value in bits [2:] along with the delay time unit specified for that particular fault.
			101	Retry 5 times	The PMBus device attempts to restart 5 times. If the device fails to restart, it disables the output and remains off until the fault is cleared as described in Section 10.7. The time between the start of each attempt to restart is set by the value in bits [2:] along with the delay time unit specified for that particular fault.
			110	Retry 6 times	The PMBus device attempts to restart 6 times. If the device fails to restart, it disables the output and remains off until the fault is cleared as described in Section 10.7. The time between the start of each attempt to restart is set by the value in bits [2:] along with the delay time unit specified for that particular fault.
			111	Retry Continuously	The PMBus device attempts to restart continuously, without limitation, until it is commanded OFF (by the CONTROL pin or OPERATION command or both), bias power is removed, or another fault condition causes the unit to shut down.
2:0	Retry Time and Delay Time	Number of delay time units. Used for either the amount of time the device is to continue operating after a fault is detected or for the amount of time between attempts to restart. The time unit is set in register 0xD2.	0	1	
			1	2	
			2	4	
			3	8	
			4	16	
			5	32	
			6	64	
			7	128	

**VOUT\_OV\_WARN\_LIMIT (0x42)**

Transfer Type: R/W Word

Description: Output over voltage warning limit.

Bit	Description	Format	Unit
15:0	Output over voltage warning limit.	Vout Mode Unsigned	V

**VOUT\_UV\_WARN\_LIMIT (0x43)**

Transfer Type: R/W Word

Description: Output under voltage warning limit.

Bit	Description	Format	Unit
15:0	Output under voltage warning limit.	Vout Mode Unsigned	V

**BMR458 series** Fully regulated DC/DC Converters  
Input 36-75 V, Output up to 50 A / 600 W

1/28701-BMR458 0032 revA July 2018

© Flex

#### VOUT\_UV\_FAULT\_LIMIT (0x44)

Transfer Type: R/W Word

Description: Output under voltage fault limit.

Bit	Description	Format	Unit
15:0	Output under voltage fault limit.	Vout Mode Unsigned	V

#### VOUT\_UV\_FAULT\_RESPONSE (0x45)

Transfer Type: R/W Byte

Description: Output under voltage fault response.

Bit	Function	Description	Value	Function	Description
7:6	Response	Describes the device interruption operation. 00b - The PMBus device continues operation without interruption. 01b - The PMBus device continues operation for the delay time specified by bits [2:0] and the delay time unit specified for that particular fault. If the fault condition is still present at the end of the delay time, the unit responds as programmed in the Retry Setting (bits [5:3]). 10b - The device shuts down (disables the output) and responds according to the Retry Setting in bits [5:3]. 11b - The device's output is disabled while the fault is present. Operation resumes and the output is enabled when the fault condition no longer exists.	00	Ignore Fault	The PMBus device continues operation without interruption.
			01	Perform Retries while Operating	The PMBus device continues operation for the delay time specified by bits [2:0] and the delay time unit specified for that particular fault. If the fault condition is still present at the end of the delay time, the unit responds as programmed in the Retry Setting (bits [5:3]).
			10	Disable and retry	The device shuts down (disables the output) and responds according to the retry setting in bits [5:3].
			11	Disable until Fault Cleared	A fault can be cleared in several ways: The bit is individually cleared, The device receives a CLEAR_FAULTS command, a RESET signal (if one exists) is asserted, the output is commanded through the CTRL pin, the OPERATION command, or the combined action of the CTRL pin and OPERATION command, to turn off and then to turn back on, or Bias power is removed from the PMBus device.
5:3	Retries	The device attempts to restart the number of times set by these bits. 000b means the device does not attempt a restart. 111b means the device attempts restarting continuously.	000	Do Not Retry	A zero value for the Retry Setting means that the unit does not attempt to restart. The output remains disabled until the fault is cleared (Section 10.7).
			001	Retry Once	The PMBus device attempts to restart 1 time. If the device fails to restart, it disables the output and remains off until the fault is cleared as described in Section 10.7. The time between the start of each attempt to restart is set by the value in bits [2:] along with the delay time unit specified for that particular fault.

**BMR458 series** Fully regulated DC/DC Converters  
 Input 36-75 V, Output up to 50 A / 600 W

1/28701-BMR458 0032 revA July 2018  
 © Flex

Bit	Function	Description	Value	Function	Description
			010	Retry Twice	The PMBus device attempts to restart 2 times. If the device fails to restart, it disables the output and remains off until the fault is cleared as described in Section 10.7. The time between the start of each attempt to restart is set by the value in bits [2:] along with the delay time unit specified for that particular fault.
			011	Retry 3 times	The PMBus device attempts to restart 3 times. If the device fails to restart, it disables the output and remains off until the fault is cleared as described in Section 10.7. The time between the start of each attempt to restart is set by the value in bits [2:] along with the delay time unit specified for that particular fault.
			100	Retry 4 times	The PMBus device attempts to restart 4 times. If the device fails to restart, it disables the output and remains off until the fault is cleared as described in Section 10.7. The time between the start of each attempt to restart is set by the value in bits [2:] along with the delay time unit specified for that particular fault.
			101	Retry 5 times	The PMBus device attempts to restart 5 times. If the device fails to restart, it disables the output and remains off until the fault is cleared as described in Section 10.7. The time between the start of each attempt to restart is set by the value in bits [2:] along with the delay time unit specified for that particular fault.
			110	Retry 6 times	The PMBus device attempts to restart 6 times. If the device fails to restart, it disables the output and remains off until the fault is cleared as described in Section 10.7. The time between the start of each attempt to restart is set by the value in bits [2:] along with the delay time unit specified for that particular fault.
			111	Retry Continuously	The PMBus device attempts to restart continuously, without limitation, until it is commanded OFF (by the CONTROL pin or OPERATION command or both), bias power is removed, or another fault condition causes the unit to shut down.
2:0	Retry Time and Delay Time		0	1	
			1	2	
			2	4	
			3	8	
			4	16	
			5	32	

**BMR458 series Fully regulated DC/DC Converters**  
 Input 36-75 V, Output up to 50 A / 600 W

1/28701-BMR458 0032 revA

July 2018

© Flex

Bit	Function	Description	Value	Function	Description
		Number of delay time units. Used for either the amount of time the device is to continue operating after a fault is detected or for the amount of time between attempts to restart. The time unit is set in register 0xD2.	6	64	
			7	128	

**IOUT\_OC\_FAULT\_LIMIT (0x46)**

Transfer Type: R/W Word

Description: Output over current limit.

Bit	Description	Format	Unit
15:0	Output over current fault limit.	Linear	A

**IOUT\_OC\_FAULT\_RESPONSE (0x47)**

Transfer Type: R/W Byte

Description: Output over current fault response.

Bit	Function	Description	Value	Function	Description
7:6	Response	For all values of bits [7:6], the device: Sets the corresponding fault bit in the status registers and If the device supports notifying the host, it does so.	00	Ignore Fault	The PMBus device continues to operate indefinitely while maintaining the output current at the value set by IOUT_OC_FAULT_LIMIT without regard to the output voltage (known as constant-current or brickwall limiting).
			01	Conditioned constant current	The PMBus device continues to operate indefinitely while maintaining the output current at the value set by IOUT_OC_FAULT_LIMIT as long as the output voltage remains above the minimum value specified by IOUT_OC_LV_FAULT_LIMIT. If the output voltage is pulled down to less than that value, then the PMBus device shuts down and responds according to the Retry setting in bits [5:3].
			10	Delay w/ Const. Current & Retry	The PMBus device continues to operate, maintaining the output current at the value set by IOUT_OC_FAULT_LIMIT without regard to the output voltage, for the delay time set by bits [2:0] and the delay time units for specified in the IOUT_OC_FAULT_RESPONSE . If the device is still operating in current limiting at the end of the delay time, the device responds as programmed by the Retry Setting in bits [5:3].
			11	Disable and Retry	The PMBus device shuts down and responds as programmed by the Retry Setting in bits [5:3].

**BMR458 series** Fully regulated DC/DC Converters  
Input 36-75 V, Output up to 50 A / 600 W

1/28701-BMR458 0032 revA

July 2018

© Flex

Bit	Function	Description	Value	Function	Description
5:3	Retries	The device attempts to restart the number of times set by these bits. 000b means the device does not attempt a restart. 111b means the device attempts restarting continuously.	000	Do Not Retry	A zero value for the Retry Setting means that the unit does not attempt to restart. The output remains disabled until the fault is cleared (Section 10.7).
			001	Retry Once	The PMBus device attempts to restart 1 time. If the device fails to restart, it disables the output and remains off until the fault is cleared as described in Section 10.7. The time between the start of each attempt to restart is set by the value in bits [2:] along with the delay time unit specified for that particular fault.
			010	Retry Twice	The PMBus device attempts to restart 2 times. If the device fails to restart, it disables the output and remains off until the fault is cleared as described in Section 10.7. The time between the start of each attempt to restart is set by the value in bits [2:] along with the delay time unit specified for that particular fault.
			011	Retry 3 times	The PMBus device attempts to restart 3 times. If the device fails to restart, it disables the output and remains off until the fault is cleared as described in Section 10.7. The time between the start of each attempt to restart is set by the value in bits [2:] along with the delay time unit specified for that particular fault.
			100	Retry 4 times	The PMBus device attempts to restart 4 times. If the device fails to restart, it disables the output and remains off until the fault is cleared as described in Section 10.7. The time between the start of each attempt to restart is set by the value in bits [2:] along with the delay time unit specified for that particular fault.
			101	Retry 5 times	The PMBus device attempts to restart 5 times. If the device fails to restart, it disables the output and remains off until the fault is cleared as described in Section 10.7. The time between the start of each attempt to restart is set by the value in bits [2:] along with the delay time unit specified for that particular fault.

**BMR458 series** Fully regulated DC/DC Converters  
Input 36-75 V, Output up to 50 A / 600 W

1/28701-BMR458 0032 revA

July 2018

© Flex

Bit	Function	Description	Value	Function	Description
			110	Retry 6 times	The PMBus device attempts to restart 6 times. If the device fails to restart, it disables the output and remains off until the fault is cleared as described in Section 10.7. The time between the start of each attempt to restart is set by the value in bits [2:] along with the delay time unit specified for that particular fault.
			111	Retry Continuously	The PMBus device attempts to restart continuously, without limitation, until it is commanded OFF (by the CONTROL pin or OPERATION command or both), bias power is removed, or another fault condition causes the unit to shut down.
2:0	Retry Time and Delay Time	Number of delay time units. Used for either the amount of time the device is to continue operating after a fault is detected or for the amount of time between attempts to restart. The time unit is set in register 0xD2.	0	1	
			1	2	
			2	4	
			3	8	
			4	16	
			5	32	
			6	64	
			7	128	

**IOUT\_OC\_LV\_FAULT\_LIMIT (0x48)**

Transfer Type: R/W Word

Description: Set the output over-current low-voltage fault threshold.

Bit	Description	Format	Unit
15:0	Set the output over-current low-voltage fault threshold.	Vout Mode Unsigned	V

**IOUT\_OC\_WARN\_LIMIT (0x4A)**

Transfer Type: R/W Word

Description: Output over current warning limit.

Bit	Description	Format	Unit
15:0	Output over current warning limit.	Linear	A

**OT\_FAULT\_LIMIT (0x4F)**

Transfer Type: R/W Word

Description: Over temperature fault limit.

Bit	Description	Format	Unit
15:0	Over temperature fault limit.	Linear	°C

**OT\_FAULT\_RESPONSE (0x50)**

Transfer Type: R/W Byte

Description: Over temperature fault response.

Bit	Function	Description	Value	Function	Description
7:6	Response		00	Ignore Fault	The PMBus device continues operation without interruption.

**BMR458 series** Fully regulated DC/DC Converters  
Input 36-75 V, Output up to 50 A / 600 W

1/28701-BMR458 0032 revA

July 2018

© Flex

Bit	Function	Description	Value	Function	Description
			01	Perform Retries while Operating	The PMBus device continues operation for the delay time specified by bits [2:0] and the delay time unit specified for that particular fault. If the fault condition is still present at the end of the delay time, the unit responds as programmed in the Retry Setting (bits [5:3]).
			10	Disable and retry	The device shuts down (disables the output) and responds according to the retry setting in bits [5:3].
			11	Disable until Fault Cleared	A fault can be cleared in several ways: The bit is individually cleared, The device receives a CLEAR_FAULTS command, a RESET signal (if one exists) is asserted, the output is commanded through the CTRL pin, the OPERATION command, or the combined action of the CTRL pin and OPERATION command, to turn off and then to turn back on, or Bias power is removed from the PMBus device.
5:3	Retries		000	Do Not Retry	A zero value for the Retry Setting means that the unit does not attempt to restart. The output remains disabled until the fault is cleared (Section 10.7).
			001	Retry Once	The PMBus device attempts to restart 1 time. If the device fails to restart, it disables the output and remains off until the fault is cleared as described in Section 10.7. The time between the start of each attempt to restart is set by the value in bits [2:] along with the delay time unit specified for that particular fault.
			010	Retry Twice	The PMBus device attempts to restart 2 times. If the device fails to restart, it disables the output and remains off until the fault is cleared as described in Section 10.7. The time between the start of each attempt to restart is set by the value in bits [2:] along with the delay time unit specified for that particular fault.
			011	Retry 3 times	The PMBus device attempts to restart 3 times. If the device fails to restart, it disables the output and remains off until the fault is cleared as described in Section 10.7. The time between the start of each attempt to restart is set by the value in bits [2:] along with the delay time unit specified for that particular fault.



**BMR458 series** Fully regulated DC/DC Converters  
Input 36-75 V, Output up to 50 A / 600 W

1/28701-BMR458 0032 revA July 2018  
© Flex

Bit	Function	Description	Value	Function	Description
			100	Retry 4 times	The PMBus device attempts to restart 4 times. If the device fails to restart, it disables the output and remains off until the fault is cleared as described in Section 10.7. The time between the start of each attempt to restart is set by the value in bits [2:] along with the delay time unit specified for that particular fault.
			101	Retry 5 times	The PMBus device attempts to restart 5 times. If the device fails to restart, it disables the output and remains off until the fault is cleared as described in Section 10.7. The time between the start of each attempt to restart is set by the value in bits [2:] along with the delay time unit specified for that particular fault.
			110	Retry 6 times	The PMBus device attempts to restart 6 times. If the device fails to restart, it disables the output and remains off until the fault is cleared as described in Section 10.7. The time between the start of each attempt to restart is set by the value in bits [2:] along with the delay time unit specified for that particular fault.
			111	Retry Continuously	The PMBus device attempts to restart continuously, without limitation, until it is commanded OFF (by the CONTROL pin or OPERATION command or both), bias power is removed, or another fault condition causes the unit to shut down.
2:0	Retry Time and Delay Time	Number of delay time units. Used for either the amount of time the device is to continue operating after a fault is detected or for the amount of time between attempts to restart. The time unit is set in register 0xD2.	0	1	
			1	2	
			2	4	
			3	8	
			4	16	
			5	32	
			6	64	
			7	128	

**OT\_WARN\_LIMIT (0x51)**

Transfer Type: R/W Word

Description: Over temperature warning limit.

Bit	Description	Format	Unit
15:0	Over temperature warning limit.	Linear	°C

**UT\_WARN\_LIMIT (0x52)**

Transfer Type: R/W Word

Description: Under temperature warning limit.

Bit	Description	Format	Unit
15:0	Under temperature warning limit.	Linear	°C

**BMR458 series** Fully regulated DC/DC Converters  
Input 36-75 V, Output up to 50 A / 600 W

1/28701-BMR458 0032 revA

July 2018

© Flex

**UT\_FAULT\_LIMIT (0x53)**

Transfer Type: R/W Word

Description: Under temperature fault limit.

Bit	Description	Format	Unit
15:0	Under temperature fault limit.	Linear	°C

**UT\_FAULT\_RESPONSE (0x54)**

Transfer Type: R/W Byte

Description: Under temperature fault response.

Bit	Function	Description	Value	Function	Description
7:6	Response		00	Ignore Fault	The PMBus device continues operation without interruption.
			01	Perform Retries while Operating	The PMBus device continues operation for the delay time specified by bits [2:0] and the delay time unit specified for that particular fault. If the fault condition is still present at the end of the delay time, the unit responds as programmed in the Retry Setting (bits [5:3]).
			10	Disable and retry	The device shuts down (disables the output) and responds according to the retry setting in bits [5:3].
			11	Disable until Fault Cleared	A fault can be cleared in several ways: The bit is individually cleared, The device receives a CLEAR_FAULTS command, a RESET signal (if one exists) is asserted, the output is commanded through the CTRL pin, the OPERATION command, or the combined action of the CTRL pin and OPERATION command, to turn off and then to turn back on, or Bias power is removed from the PMBus device.
5:3	Retries		000	Do Not Retry	A zero value for the Retry Setting means that the unit does not attempt to restart. The output remains disabled until the fault is cleared (Section 10.7).
			001	Retry Once	The PMBus device attempts to restart 1 time. If the device fails to restart, it disables the output and remains off until the fault is cleared as described in Section 10.7. The time between the start of each attempt to restart is set by the value in bits [2:] along with the delay time unit specified for that particular fault.

**BMR458 series** Fully regulated DC/DC Converters  
 Input 36-75 V, Output up to 50 A / 600 W

1/28701-BMR458 0032 revA July 2018

© Flex

Bit	Function	Description	Value	Function	Description
			010	Retry Twice	The PMBus device attempts to restart 2 times. If the device fails to restart, it disables the output and remains off until the fault is cleared as described in Section 10.7. The time between the start of each attempt to restart is set by the value in bits [2:] along with the delay time unit specified for that particular fault.
			011	Retry 3 times	The PMBus device attempts to restart 3 times. If the device fails to restart, it disables the output and remains off until the fault is cleared as described in Section 10.7. The time between the start of each attempt to restart is set by the value in bits [2:] along with the delay time unit specified for that particular fault.
			100	Retry 4 times	The PMBus device attempts to restart 4 times. If the device fails to restart, it disables the output and remains off until the fault is cleared as described in Section 10.7. The time between the start of each attempt to restart is set by the value in bits [2:] along with the delay time unit specified for that particular fault.
			101	Retry 5 times	The PMBus device attempts to restart 5 times. If the device fails to restart, it disables the output and remains off until the fault is cleared as described in Section 10.7. The time between the start of each attempt to restart is set by the value in bits [2:] along with the delay time unit specified for that particular fault.
			110	Retry 6 times	The PMBus device attempts to restart 6 times. If the device fails to restart, it disables the output and remains off until the fault is cleared as described in Section 10.7. The time between the start of each attempt to restart is set by the value in bits [2:] along with the delay time unit specified for that particular fault.
			111	Retry Continuously	The PMBus device attempts to restart continuously, without limitation, until it is commanded OFF (by the CONTROL pin or OPERATION command or both), bias power is removed, or another fault condition causes the unit to shut down.
2:0	Retry Time and Delay Time		0	1	
			1	2	
			2	4	
			3	8	
			4	16	
			5	32	

**BMR458 series Fully regulated DC/DC Converters**  
 Input 36-75 V, Output up to 50 A / 600 W

1/28701-BMR458 0032 revA

July 2018

© Flex

Bit	Function	Description	Value	Function	Description
		Number of delay time units. Used for either the amount of time the device is to continue operating after a fault is detected or for the amount of time between attempts to restart. The time unit is set in register 0xD2.	6	64	
			7	128	

**VIN\_OV\_FAULT\_LIMIT (0x55)**

Transfer Type: R/W Word

Description: Input over voltage fault limit.

Bit	Description	Format	Unit
15:0	Input over voltage fault limit.	Linear	V

**VIN\_OV\_FAULT\_RESPONSE (0x56)**

Transfer Type: R/W Byte

Description: Input over voltage fault response.

Bit	Function	Description	Value	Function	Description
7:6	Response		00	Ignore Fault	The PMBus device continues operation without interruption.
			01	Perform Retries while Operating	The PMBus device continues operation for the delay time specified by bits [2:0] and the delay time unit specified for that particular fault. If the fault condition is still present at the end of the delay time, the unit responds as programmed in the Retry Setting (bits [5:3]).
			10	Disable and retry	The device shuts down (disables the output) and responds according to the retry setting in bits [5:3].
			11	Disable until Fault Cleared	A fault can be cleared in several ways: The bit is individually cleared, The device receives a CLEAR_FAULTS command, a RESET signal (if one exists) is asserted, the output is commanded through the CTRL pin, the OPERATION command, or the combined action of the CTRL pin and OPERATION command, to turn off and then to turn back on, or Bias power is removed from the PMBus device.
5:3	Retries		000	Do Not Retry	A zero value for the Retry Setting means that the unit does not attempt to restart. The output remains disabled until the fault is cleared (Section 10.7).

**BMR458 series** Fully regulated DC/DC Converters  
Input 36-75 V, Output up to 50 A / 600 W

1/28701-BMR458 0032 revA

July 2018

© Flex

Bit	Function	Description	Value	Function	Description
			001	Retry Once	The PMBus device attempts to restart 1 time. If the device fails to restart, it disables the output and remains off until the fault is cleared as described in Section 10.7. The time between the start of each attempt to restart is set by the value in bits [2:] along with the delay time unit specified for that particular fault.
			010	Retry Twice	The PMBus device attempts to restart 2 times. If the device fails to restart, it disables the output and remains off until the fault is cleared as described in Section 10.7. The time between the start of each attempt to restart is set by the value in bits [2:] along with the delay time unit specified for that particular fault.
			011	Retry 3 times	The PMBus device attempts to restart 3 times. If the device fails to restart, it disables the output and remains off until the fault is cleared as described in Section 10.7. The time between the start of each attempt to restart is set by the value in bits [2:] along with the delay time unit specified for that particular fault.
			100	Retry 4 times	The PMBus device attempts to restart 4 times. If the device fails to restart, it disables the output and remains off until the fault is cleared as described in Section 10.7. The time between the start of each attempt to restart is set by the value in bits [2:] along with the delay time unit specified for that particular fault.
			101	Retry 5 times	The PMBus device attempts to restart 5 times. If the device fails to restart, it disables the output and remains off until the fault is cleared as described in Section 10.7. The time between the start of each attempt to restart is set by the value in bits [2:] along with the delay time unit specified for that particular fault.
			110	Retry 6 times	The PMBus device attempts to restart 6 times. If the device fails to restart, it disables the output and remains off until the fault is cleared as described in Section 10.7. The time between the start of each attempt to restart is set by the value in bits [2:] along with the delay time unit specified for that particular fault.

**BMR458 series Fully regulated DC/DC Converters**  
 Input 36-75 V, Output up to 50 A / 600 W

1/28701-BMR458 0032 revA

July 2018

© Flex

Bit	Function	Description	Value	Function	Description
			111	Retry Continuously	The PMBus device attempts to restart continuously, without limitation, until it is commanded OFF (by the CONTROL pin or OPERATION command or both), bias power is removed, or another fault condition causes the unit to shut down.
2:0	Retry Time and Delay Time	Number of delay time units. Used for either the amount of time the device is to continue operating after a fault is detected or for the amount of time between attempts to restart. The time unit is set in register 0xD2.	0	1	
			1	2	
			2	4	
			3	8	
			4	16	
			5	32	
			6	64	
			7	128	

**VIN\_OV\_WARN\_LIMIT (0x57)**

Transfer Type: R/W Word

Description: Input over voltage warning limit.

Bit	Description	Format	Unit
15:0	Input over voltage warning limit.	Linear	V

**VIN\_UV\_WARN\_LIMIT (0x58)**

Transfer Type: R/W Word

Description: Input under voltage warning limit.

Bit	Description	Format	Unit
15:0	Input under voltage warning limit.	Linear	V

**VIN\_UV\_FAULT\_LIMIT (0x59)**

Transfer Type: R/W Word

Description: Input under voltage fault limit.

Bit	Description	Format	Unit
15:0	Input under voltage fault limit.	Linear	V

**VIN\_UV\_FAULT\_RESPONSE (0x5A)**

Transfer Type: R/W Byte

Description: Input under voltage fault response.

Bit	Function	Description	Value	Function	Description
7:6	Response		00	Ignore Fault	The PMBus device continues operation without interruption.
			01	Perform Retries while Operating	The PMBus device continues operation for the delay time specified by bits [2:0] and the delay time unit specified for that particular fault. If the fault condition is still present at the end of the delay time, the unit responds as programmed in the Retry Setting (bits [5:3]).
			10	Disable and retry	The device shuts down (disables the output) and responds according to the retry setting in bits [5:3].

**BMR458 series** Fully regulated DC/DC Converters  
Input 36-75 V, Output up to 50 A / 600 W

1/28701-BMR458 0032 revA

July 2018

© Flex

Bit	Function	Description	Value	Function	Description
			11	Disable until Fault Cleared	A fault can cleared in several ways: The bit is individually cleared, The device receives a CLEAR_FAULTS command, a RESET signal (if one exists) is asserted, the output is commanded through the CTRL pin, the OPERATION command, or the combined action of the CTRL pin and OPERATION command, to turn off and then to turn back on, or Bias power is removed from the PMBus device.
5:3	Retries		000	Do Not Retry	A zero value for the Retry Setting means that the unit does not attempt to restart. The output remains disabled until the fault is cleared (Section 10.7).
			001	Retry Once	The PMBus device attempts to restart 1 time. If the device fails to restart, it disables the output and remains off until the fault is cleared as described in Section 10.7. The time between the start of each attempt to restart is set by the value in bits [2:] along with the delay time unit specified for that particular fault.
			010	Retry Twice	The PMBus device attempts to restart 2 times. If the device fails to restart, it disables the output and remains off until the fault is cleared as described in Section 10.7. The time between the start of each attempt to restart is set by the value in bits [2:] along with the delay time unit specified for that particular fault.
			011	Retry 3 times	The PMBus device attempts to restart 3 times. If the device fails to restart, it disables the output and remains off until the fault is cleared as described in Section 10.7. The time between the start of each attempt to restart is set by the value in bits [2:] along with the delay time unit specified for that particular fault.
			100	Retry 4 times	The PMBus device attempts to restart 4 times. If the device fails to restart, it disables the output and remains off until the fault is cleared as described in Section 10.7. The time between the start of each attempt to restart is set by the value in bits [2:] along with the delay time unit specified for that particular fault.

**BMR458 series** Fully regulated DC/DC Converters  
Input 36-75 V, Output up to 50 A / 600 W

1/28701-BMR458 0032 revA

July 2018

© Flex

Bit	Function	Description	Value	Function	Description
			101	Retry 5 times	The PMBus device attempts to restart 5 times. If the device fails to restart, it disables the output and remains off until the fault is cleared as described in Section 10.7. The time between the start of each attempt to restart is set by the value in bits [2:] along with the delay time unit specified for that particular fault.
			110	Retry 6 times	The PMBus device attempts to restart 6 times. If the device fails to restart, it disables the output and remains off until the fault is cleared as described in Section 10.7. The time between the start of each attempt to restart is set by the value in bits [2:] along with the delay time unit specified for that particular fault.
			111	Retry Continuously	The PMBus device attempts to restart continuously, without limitation, until it is commanded OFF (by the CONTROL pin or OPERATION command or both), bias power is removed, or another fault condition causes the unit to shut down.
2:0	Retry Time and Delay Time	Number of delay time units. Used for either the amount of time the device is to continue operating after a fault is detected or for the amount of time between attempts to restart. The time unit is set in register 0xD2.	0	1	
			1	2	
			2	4	
			3	8	
			4	16	
			5	32	
			6	64	
			7	128	

**POWER\_GOOD\_ON (0x5E)**

Transfer Type: R/W Word

Description: Sets the output voltage threshold for asserting PG (Power Good).

Bit	Description	Format	Unit
15:0	The POWER_GOOD_ON command sets the output voltage at which an optional POWER_GOOD signal should be asserted.	Vout Mode Unsigned	V

**POWER\_GOOD\_OFF (0x5F)**

Transfer Type: R/W Word

Description: If the output voltage is lower than this one, negate power good if power good is enabled through MFR\_MULTI\_PIN\_CONFIG and set the power good bit to 1 in PMBUS status.

Bit	Description	Format	Unit
15:0	If the output voltage is lower than this one, negate power good if power good is enabled through MFR_MULTI_PIN_CONFIG and set the power good bit to 1 in PMBUS status.	Vout Mode Unsigned	V

**TON\_DELAY (0x60)**

Transfer Type: R/W Word

Description: Sets the turn-on delay time

Bit	Description	Format	Unit
15:0	Sets the delay time from ENABLE to start of VOUT rise.	Direct	ms



**BMR458 series** Fully regulated DC/DC Converters  
Input 36-75 V, Output up to 50 A / 600 W

1/28701-BMR458 0032 revA July 2018

© Flex

#### TON\_RISE (0x61)

Transfer Type: R/W Word

Description: Sets the turn-on transition time.

Bit	Description	Format	Unit
15:0	Sets the rise time of VOUT after ENABLE and TON_DELAY.	Direct	ms

#### TON\_MAX\_FAULT\_LIMIT (0x62)

Transfer Type: R/W Word

Description: Sets an upper limit, in milliseconds, on how long the unit can attempt to power up the output without reaching the output undervoltage fault limit.

Bit	Description	Format	Unit
15:0	A value of 0 milliseconds means that there is no limit and that the unit can attempt to bring up the output voltage indefinitely.	Direct	ms

#### TON\_MAX\_FAULT\_RESPONSE (0x63)

Transfer Type: R/W Byte

Description: Only some of the response types are supported.

Bit	Function	Description	Value	Function	Description
7:6	Response		00	Ignore Fault	The PMBus device continues operation without interruption.
			01	Perform Retries while Operating	The PMBus device continues operation for the delay time specified by bits [2:0] and the delay time unit specified for that particular fault. If the fault condition is still present at the end of the delay time, the unit responds as programmed in the Retry Setting (bits [5:3]).
			10	Disable and retry	The device shuts down (disables the output) and responds according to the retry setting in bits [5:3].
			11	Disable until Fault Cleared	A fault can be cleared in several ways: The bit is individually cleared, The device receives a CLEAR_FAULTS command, a RESET signal (if one exists) is asserted, the output is commanded through the CTRL pin, the OPERATION command, or the combined action of the CTRL pin and OPERATION command, to turn off and then to turn back on, or Bias power is removed from the PMBus device.
5:3	Retries		000	Do Not Retry	A zero value for the Retry Setting means that the unit does not attempt to restart. The output remains disabled until the fault is cleared (Section 10.7).

**BMR458 series** Fully regulated DC/DC Converters  
Input 36-75 V, Output up to 50 A / 600 W

1/28701-BMR458 0032 revA

July 2018

© Flex

Bit	Function	Description	Value	Function	Description
			001	Retry Once	The PMBus device attempts to restart 1 time. If the device fails to restart, it disables the output and remains off until the fault is cleared as described in Section 10.7. The time between the start of each attempt to restart is set by the value in bits [2:] along with the delay time unit specified for that particular fault.
			010	Retry Twice	The PMBus device attempts to restart 2 times. If the device fails to restart, it disables the output and remains off until the fault is cleared as described in Section 10.7. The time between the start of each attempt to restart is set by the value in bits [2:] along with the delay time unit specified for that particular fault.
			011	Retry 3 times	The PMBus device attempts to restart 3 times. If the device fails to restart, it disables the output and remains off until the fault is cleared as described in Section 10.7. The time between the start of each attempt to restart is set by the value in bits [2:] along with the delay time unit specified for that particular fault.
			100	Retry 4 times	The PMBus device attempts to restart 4 times. If the device fails to restart, it disables the output and remains off until the fault is cleared as described in Section 10.7. The time between the start of each attempt to restart is set by the value in bits [2:] along with the delay time unit specified for that particular fault.
			101	Retry 5 times	The PMBus device attempts to restart 5 times. If the device fails to restart, it disables the output and remains off until the fault is cleared as described in Section 10.7. The time between the start of each attempt to restart is set by the value in bits [2:] along with the delay time unit specified for that particular fault.
			110	Retry 6 times	The PMBus device attempts to restart 6 times. If the device fails to restart, it disables the output and remains off until the fault is cleared as described in Section 10.7. The time between the start of each attempt to restart is set by the value in bits [2:] along with the delay time unit specified for that particular fault.

**BMR458 series** Fully regulated DC/DC Converters  
Input 36-75 V, Output up to 50 A / 600 W

1/28701-BMR458 0032 revA July 2018  
© Flex

Bit	Function	Description	Value	Function	Description
			111	Retry Continuously	The PMBus device attempts to restart continuously, without limitation, until it is commanded OFF (by the CONTROL pin or OPERATION command or both), bias power is removed, or another fault condition causes the unit to shut down.
2:0	Retry Time and Delay Time	Number of delay time units. Used for either the amount of time the device is to continue operating after a fault is detected or for the amount of time between attempts to restart. The time unit is set in register 0xD2. TON_MAX_FAULT_RESPONSE time unit is referenced to VOUT FAULT time unit.	0	1	
			1	2	
			2	4	
			3	8	
			4	16	
			5	32	
			6	64	
			7	128	

**TOFF\_DELAY (0x64)**

Transfer Type: R/W Word

Description: Sets the turn-off delay.

Bit	Description	Format	Unit
15:0	Sets the delay time from DISABLE to start of VOUT fall.	Direct	ms

**TOFF\_FALL (0x65)**

Transfer Type: R/W Word

Description: Sets the turn-off transition time.

Bit	Description	Format	Unit
15:0	Sets the fall time for VOUT after DISABLE and TOFF_DELAY.	Direct	ms

**TOFF\_MAX\_WARN\_LIMIT (0x66)**

Transfer Type: R/W Word

Description: Sets an upper limit, in milliseconds, on how long the unit can attempt to power down the output without reaching 12.5% of the output voltage programmed at the time the unit is turned off.

Bit	Description	Format	Unit
15:0		Direct	ms

**STATUS\_BYTE (0x78)**

Transfer Type: Read Byte

Description: Returns a brief fault/warning status byte.

Bit	Function	Description	Value	Description
6	Off	This bit is asserted if the unit is not providing power to the output, regardless of the reason, including simply not being enabled.	0	No fault
			1	Fault
5	Vout Overvoltage Fault	An output overvoltage fault has occurred.	0	No fault
			1	Fault
4	Iout Overcurrent Fault	An output overcurrent fault has occurred.	0	No fault
			1	Fault
3	Vin Undervoltage Fault	An input undervoltage fault has occurred.	0	No fault
			1	Fault
2	Temperature	A temperature fault or warning has occurred.	0	No fault
			1	Fault
1	Communication/Logic	A communications, memory or logic fault has occurred.	0	No fault
			1	Fault
0	None of the Above	A fault or warning not listed in bits [7:1] has occurred.	0	No fault
			1	Fault

**BMR458 series** Fully regulated DC/DC Converters  
Input 36-75 V, Output up to 50 A / 600 W

1/28701-BMR458 0032 revA

July 2018

© Flex

**STATUS\_WORD (0x79)**

Transfer Type: Read Word

Description: Returns an extended fault/warning status byte.

Bit	Function	Description	Value	Description
15	Vout	An output voltage fault or warning has occurred.	0	No fault
			1	Fault
14	Iout/Pout	An output current or output power fault or warning has occurred.	0	No Fault.
			1	Fault.
13	Input	An input voltage, input current, or input power fault or warning has occurred.	0	No Fault.
			1	Fault.
11	Power-Good	The Power-Good signal, if present, is negated.	0	No Fault.
			1	Fault.
6	Off	This bit is asserted if the unit is not providing power to the output, regardless of the reason, including simply not being enabled.	0	No fault
			1	Fault
5	Vout Overvoltage Fault	An output overvoltage fault has occurred.	0	No Fault.
			1	Fault.
4	Iout Overcurrent Fault	An output overcurrent fault has occurred.	0	No Fault.
			1	Fault.
3	Vin Undervoltage Fault	An input undervoltage fault has occurred.	0	No Fault.
			1	Fault.
2	Temperature	A temperature fault or warning has occurred.	0	No Fault.
			1	Fault.
1	Communication/Logic	A communications, memory or logic fault has occurred.	0	No fault.
			1	Fault.
0	None of the Above	A fault or warning not listed in bits [7:1] has occurred.	0	No fault.
			1	Fault.

**STATUS\_VOUT (0x7A)**

Transfer Type: Read Byte

Description: Returns Vout-related fault/warning status bits.

Bit	Function	Description	Value	Description
7	Vout Overvoltage Fault	Vout Overvoltage Fault.	0	No Fault.
			1	Fault.
6	Vout Overvoltage Warning	Vout Overvoltage Warning.	0	No Warning.
			1	Warning.
5	Vout Undervoltage Warning	Vout Undervoltage Warning.	0	No Warning.
			1	Warning.
4	Vout Undervoltage Fault	Vout Undervoltage Fault.	0	No Fault.
			1	Fault.
3	Vout Max Warning	Vout Max Warning (An attempt has been made to set the output voltage to value higher than allowed by the Vout Max command (Section 13.5)).	0	No Warning.
			1	Warning.
2	Ton Max Fault	Ton-Max Fault.	0	No Fault
			1	Fault.
1	Toff Max Warning	Toff Max Warning.	0	No Warning.
			1	Warning.

**STATUS\_IOUT (0x7B)**

Transfer Type: Read Byte

Description: Returns Iout-related fault/warning status bits.

Bit	Function	Description	Value	Description
7	Iout Overcurrent Fault	Iout Overcurrent Fault.	0	No Fault.
			1	Fault.
6	Iout Overcurrent And Low Voltage Fault	Iout Overcurrent and low voltage fault.	0	No Fault.
			1	Fault.
5	Iout Over Current Warning	Iout Overcurrent Warning.	0	No Warning.
			1	Warning.

**BMR458 series Fully regulated DC/DC Converters**  
 Input 36-75 V, Output up to 50 A / 600 W

1/28701-BMR458 0032 revA July 2018

© Flex

Bit	Function	Description	Value	Description
4	Iout Undercurrent Fault	Iout Undercurrent Fault.	0	No Fault.
			1	Fault.

**STATUS\_INPUT (0x7C)**

Transfer Type: Read Byte

Description: Returns VIN/IIN-related fault/warning status bits.

Bit	Function	Description	Value	Description
7	Vin Overvoltage Fault	Vin Overvoltage Fault.	0	No Fault.
			1	Fault.
6	Vin Overvoltage Warning	VIN Overvoltage Warning.	0	No Warning.
			1	Warning.
5	Vin Undervoltage Warning	Vin Undervoltage Warning.	0	No Warning.
			1	Warning.
4	Vin Undervoltage Fault	Vin Undervoltage Fault.	0	No Fault.
			1	Fault.
3	Insufficient Vin	Asserted when either the input voltage has never exceeded the input turn-on threshold Vin-On, or if the unit did start, the input voltage decreased below the turn-off threshold.	0	No Insufficient VIN encountered yet.
			1	Insufficient Unit is off.

**STATUS\_TEMPERATURE (0x7D)**

Transfer Type: Read Byte

Description: Returns the temperature-related fault/warning status bits

Bit	Function	Description	Value	Description
7	Overtemperature Fault	Overtemperature Fault.	0	No Fault.
			1	Fault.
6	Overtemperature Warning	Overtemperature Warning.	0	No Warning.
			1	Warning.
5	Undertemperature Warning	Undertemperature Warning.	0	No Warning.
			1	Warning.
4	Undertemperature Fault	Undertemperature Fault.	0	No Fault.
			1	Fault.

**STATUS\_CML (0x7E)**

Transfer Type: Read Byte

Description: Returns Communication/Logic/Memory-related fault/warning status bits.

Bit	Function	Description	Value	Description
7	Invalid Or Unsupported Command Received	Invalid Or Unsupported Command Received.	0	No Invalid Command Received.
			1	Invalid Command Received.
6	Invalid Or Unsupported Data Received	Invalid Or Unsupported Data Received.	0	No Invalid Data Received.
			1	Invalid Data Received.
5	Packet Error Check Failed	Packet Error Check Failed.	0	No Failure.
			1	Failure.
4	Memory Fault Detected	Memory Fault Detected.	0	No Fault.
			1	Fault.
1	Other Communication Fault	A communication fault other than the ones listed in this table has occurred.	0	No Fault.
			1	Fault.
0	Memory Or Logic Fault	Other Memory Or Logic Fault has occurred.	0	No Fault.
			1	Fault.

**READ\_VIN (0x88)**

Transfer Type: Read Word

Description: Returns the measured input voltage.

**BMR458 series Fully regulated DC/DC Converters**  
 Input 36-75 V, Output up to 50 A / 600 W

1/28701-BMR458 0032 revA July 2018

© Flex

Bit	Description	Format	Unit
15:0	Returns the input voltage reading.	Linear	V

**READ\_VOUT (0x8B)**

Transfer Type: Read Word

Description: Returns the measured output voltage.

Bit	Description	Format	Unit
15:0	Returns the measured output voltage.	Vout Mode Unsigned	V

**READ\_IOUT (0x8C)**

Transfer Type: Read Word

Description: Returns the measured output current.

Bit	Description	Format	Unit
15:0	The device will NACK this command when not enabled and not in the USER_CONFIG monitor mode.	Linear	A

**READ\_TEMPERATURE\_1 (0x8D)**

Transfer Type: Read Word

Description: Returns the measured temperature (internal).

Bit	Description	Format	Unit
15:0		Linear	°C

**READ\_TEMPERATURE\_2 (0x8E)**

Transfer Type: Read Word

Description: Returns the measured temperature (internal).

Bit	Description	Format	Unit
15:0		Linear	°C

**READ\_DUTY\_CYCLE (0x94)**

Transfer Type: Read Word

Description: Returns the measured duty cycle in percent.

Bit	Description	Format	Unit
15:0	Returns the target duty cycle during the ENABLE state. The device will NACK this command when not enabled and not in the USER_CONFIG monitor mode.	Linear	%

**READ\_FREQUENCY (0x95)**

Transfer Type: Read Word

Description: Returns the measured SYNC frequency.

Bit	Description	Format	Unit
15:0	Returns the measured operating switch frequency. The device will NACK this command when not enabled and not in the USER_CONFIG monitor mode.	Direct	kHz

**PMBUS\_REVISION (0x98)**

Transfer Type: Read Byte

Description: Returns the PMBus revision number for this device.

Bit	Function	Description	Value	Function	Description
7:4	Part I Revision	Part I Revision.	0x0	1.0	Part I Revision 1.0.
			0x1	1.1	Part I Revision 1.1.
			0x2	1.2	Part I Revision 1.2.
			0x3	1.3	Part I Revision 1.3.
3:0	Part II Revision	Part II Revision.	0x0	1.0	Part II Revision 1.0.
			0x1	1.1	Part II Revision 1.1.

**BMR458 series** Fully regulated DC/DC Converters  
 Input 36-75 V, Output up to 50 A / 600 W

1/28701-BMR458 0032 revA July 2018

© Flex

Bit	Function	Description	Value	Function	Description
			0x2	1.2	Part II Revision 1.2.
			0x3	1.3	Part II Revision 1.3.

**MFR\_ID (0x99)**

Transfer Type: R/W Block (12 bytes)

Description: Sets the Manufacturers ID

Bit	Description	Format
95:0	Maximum of 12 characters.	ASCII

**MFR\_MODEL (0x9A)**

Transfer Type: R/W Block (20 bytes)

Description: Sets the MFR MODEL string.

Bit	Description	Format
159:0	Maximum of 20 characters.	ASCII

**MFR\_REVISION (0x9B)**

Transfer Type: R/W Block (12 bytes)

Description: Sets the MFR revision string.

Bit	Description	Format
95:0	Maximum of 12 characters.	ASCII

**MFR\_LOCATION (0x9C)**

Transfer Type: R/W Block (12 bytes)

Description: Sets the MFR location string.

Bit	Description	Format
95:0	Maximum of 12 characters.	ASCII

**MFR\_DATE (0x9D)**

Transfer Type: R/W Block (12 bytes)

Description: This command returns the date the regulator was manufactured.

Bit	Description	Format
95:0	Maximum of 12 characters.	ASCII

**MFR\_SERIAL (0x9E)**

Transfer Type: R/W Block (20 bytes)

Description: This command returns a string of 13 characters and numbers that provides a unique identification of the regulator.

Bit	Description	Format
159:0	Maximum of 20 characters.	ASCII

**USER\_DATA\_00 (0xB0)**

Transfer Type: R/W Block (16 bytes)

Description: User data

Bit	Description	Format
127:0	16 bytes of user data.	ASCII

**MFR\_PGOOD\_POLARITY (0xD0)**

Transfer Type: R/W Byte

Description: Power good polarity (1:active high; 0: active low).

Bit	Description	Value	Function	Description
7:0	Power good polarity (1:active high; 0: active low).	0x00	Active Low	
		0x01	Active High	

**BMR458 series** Fully regulated DC/DC Converters  
Input 36-75 V, Output up to 50 A / 600 W

1/28701-BMR458 0032 revA July 2018

© Flex

#### MFR\_FAST\_OCP\_CFG (0xD1)

Transfer Type: R/W Word

Description: Set the fast OCP threshold

Bit	Function	Description	Format	Unit
12:8	OCP samples	Sets the Number of over current samples before trigger the OCP.	Integer Unsigned	samples
6:0	OCP level	Sets the level for triggering the fast OCP, resolution is in 128 divisions of 2.5V referenced to the maximum readout current.	Integer Unsigned	level

Bit	Function	Description	Value	Function	Description
7	Enable/Disable	Enable or disable Fast OCP	0	Disable	Disables Fast OCP
			1	Enable	Enables Fast OCP

#### MFR\_RESPONSE\_UNIT\_CFG (0xD2)

Transfer Type: R/W Byte

Description: Defines the basic units 1ms, 10ms, 100ms or 1 sec for each of the four basic responses Vout, Vin, Iout and Temperature. The Configured time is calculated as: Configured time = (Retry Time and Delay Time value in specific Fault response) x (unit in 0xD2)

Bit	Function	Description	Value	Function	Description
7:6	VOUT response delay unit	Set the fault response delay unit according to configured delay time for VOUT_OV_FAULT_RESPONSE and VOUT_UV_FAULT_RESPONSE.	0	1 ms/unit	
			1	10 ms/unit	
			2	100 ms/unit	
			3	1 s/unit	
5:4	Vin response delay unit	Set the fault response delay unit according to configured delay time for VIN_OV_FAULT_RESPONSE and VIN_UV_FAULT_RESPONSE.	0	1 ms/unit	
			1	10 ms/unit	
			2	100 ms/unit	
			3	1 s/unit	
3:2	IOUT response delay unit	Set the fault response delay unit according to configured delay time for IOUT_OC_FAULT_RESPONSE and IOUT_OC_FAULT_RESPONSE.	0	1 ms/unit	
			1	10 ms/unit	
			2	100 ms/unit	
			3	1 s/unit	
1:0	Temperature response delay unit	Set the fault response delay unit according to configured delay time for OT_FAULT_RESPONSE and UT_FAULT_RESPONSE.	0	1 ms/unit	
			1	10 ms/unit	
			2	100 ms/unit	
			3	1 s/unit	

#### MFR\_VIN\_SCALE\_MONITOR (0xD3)

Transfer Type: Read Block (4 bytes)

Description: Vin Scale Monitor at ON and OFF.

Bit	Function	Description	Format
31:16	Mfr. Vin Scale Monitor on	Trimmed offset at ON	Byte Array
15:0	Mfr. Vin Scale Monitor Off	Trimmed Vin Scale at OFF	Byte Array

#### MFR\_PREBIAS\_DVDT\_CFG (0xD4)

Transfer Type: R/W Block (8 bytes)

Description: Mfr. prebias dV/dt configuration



**BMR458 series Fully regulated DC/DC Converters**  
 Input 36-75 V, Output up to 50 A / 600 W

1/28701-BMR458 0032 revA July 2018

© Flex

Bit	Function	Description	Format	Unit
63:48	Mfr. Maximum allowable positive dVin/dt	This value state the max positive Vin change limit to execute a pre-bias start.	Fixed Point Signed	V/ms
47:32	Mfr. Maximum allowable negative dVin/dt	This value state the max negative Vin change limit to execute a pre-bias start.	Fixed Point Signed	V/ms
31:16	Mfr. Maximum allowable positive dVout/dt	This value state the max positive Vout change limit to execute a pre-bias start.	Fixed Point Signed	V/ms
15:0	Mfr. Maximum allowable negative dVout/dt	This value state the max negative Vout change limit to execute a pre-bias start.	Fixed Point Signed	V/ms

**MFR\_FILTER\_SELECT (0xD5)**

Transfer Type: R/W Byte

Description: Filter coefficient selection

Bit	Description	Format
7:0	Filter coefficient selection with byte 1: 0 = Vout, 1 = Iout, VFF = 2	Integer Unsigned

**MFR\_GET\_SNAPSHOT (0xD7)**

Transfer Type: Read Block (32 bytes)

Description: The MFR\_GET\_SNAPSHOT command is a 32-byte read-back of snapshot data values. When input voltage disappears during conversion the Snapshot functionality will automatically store this parametric data to NVM. If the snap shot data contains only FFh except for the counter, it means that the unit ramped up and then was commanded off before input voltage was removed.

Bit	Function	Description	Format	Unit
255:240	Snapshot Cycles	Number of shutdown in operation.	Integer Unsigned	Times
239:232	Manufacturer Specific Status Byte	Number of faults in previous power cycle.	Byte Array	
231:224	Status Other	Status other.	Byte Array	
223:216	Status CML	Status CML.	Byte Array	
215:208	Status Temperature	Status temperature.	Byte Array	
207:200	Status Vin	Status Vin.	Byte Array	
199:192	Status Iout	Status Iout.	Byte Array	
191:184	Status Vout	Status Vout.	Byte Array	
183:176	Status Byte	Status byte.	Byte Array	
175:160	Status Word	Status word.	Byte Array	
159:144	Time in operation	Duration of previous power cycle in seconds.	Integer Unsigned	seconds
143:128	Temperature 2	Read temperature from the temperature sensor not chosen in command 0xDC MFR_SELECT_TEMPERATURE_SENSOR).	Linear	°C
127:112	Temperature 1	Read temperature from the temperature sensor chosen in command 0xDC MFR_SELECT_TEMPERATURE_SENSOR).	Linear	°C
111:96	Load Current	Load current.	Linear	A

**BMR458 series Fully regulated DC/DC Converters**  
 Input 36-75 V, Output up to 50 A / 600 W

1/28701-BMR458 0032 revA July 2018

© Flex

Bit	Function	Description	Format	Unit
95:80	Output Voltage	Output voltage.	Vout Mode Unsigned	V
79:64	Input Voltage	Input voltage.	Linear	V
63:48	Duty Cycle Old	Duty cycle recorded during normal operation.	Linear	%
47:32	Load Current Old	Load current recorded during normal operation.	Linear	A
31:16	Output Voltage Old	Output voltage recorded during normal operation.	Vout Mode Unsigned	V
15:0	Input Voltage Old	Input voltage recorded during normal operation.	Linear	V

**MFR\_TEMP\_COMPENSATION (0xD8)**

Transfer Type: Read Block (8 bytes)

Description: Mfr. temperature compensation parameter

Bit	Function	Description	Format
63:56	Mfr. Temperature compensation deadtime added 2	MFR_TEMP_COMPENSATION_DT_ADD_2 defines the additional dead time used at temperature levels below temperature threshold 2. Unit is nano seconds. It's an unsigned byte, meaning the value can be 0-255.	Byte Array
55:48	Mfr. Temperature compensation deadtime hysteresis 2	MFR_TEMP_COMPENSATION_DT_HYS_2 defines a level for hysteresis i.e. temperature must rise over this level again before dead times are changed.	Byte Array
47:40	Mfr. Temperature compensation deadtime threshold 2	It is a signed byte with the temperature as an integer (°C). This defines a second temperature level for temperature compensation of dead times.	Byte Array
39:32	Mfr. Temperature compensation deadtime added 1	MFR_TEMP_COMPENSATION_DT_ADD_1 defines the additional dead time used at temperature levels below temperature threshold 1. Unit is nano seconds. It's an unsigned byte, meaning the value can be 0-255.	Byte Array
31:24	Mfr. Temperature compensation deadtime hysteresis 1	MFR_TEMP_COMPENSATION_DT_HYS_1 defines a level for hysteresis i.e. temperature must rise over this level again before dead times are changed.	Byte Array
23:16	Mfr. Temperature compensation deadtime threshold 1	It is a signed byte with the temperature as an integer (°C). This defines the first temperature level for temperature compensation of dead times.	Byte Array
15:8	Mfr. Temperature compensation EDAC slope	The second byte, TEMPERATURE_COMPENSATION_EDAC_SLOPE, sets the slope of the temperature compensation taking place above the EDAC_TEMP_COMP_TRESHOLD level. This is a signed byte in Q8 format. The unit is LSB/°C/256. Example: First byte represent 40°C so EDAC_TEMP_COMP_TRESHOLD = 40. Compensate EDAC with 25mV from 40°C to 120°C. The resolution is 1.6V/1024 = 1.56mV / LSB. To compensate for the 25mV droop over 80°C we need to add 25/80 = 0.3125mV/°C = 0.3125/1.56 LSB/°C = 0.2 LSB/°C to the reference DAC. 0.2*256 = 51 so EDAC_TEMP_COMP_SLOPE = 51	Byte Array
7:0	Mfr. Temperature compensation EDAC threshold	The first byte in the block is EDAC_TEMP_COMP_TRESHOLD. This defines the level where the temperature compensation shall begin. It is a signed byte with the temperature as an integer (°C). Example: First byte represent 40°C so EDAC_TEMP_COMP_TRESHOLD = 40. Compensate EDAC with 25mV from 40°C to 120°C. The resolution is 1.6V/1024 = 1.56mV / LSB. To compensate for the 25mV droop over 80°C we need to add 25/80 = 0.3125mV/°C = 0.3125/1.56 LSB/°C = 0.2 LSB/°C to the reference DAC. 0.2*256 = 51 so EDAC_TEMP_COMP_SLOPE = 51	Byte Array

**BMR458 series** Fully regulated DC/DC Converters  
Input 36-75 V, Output up to 50 A / 600 W

1/28701-BMR458 0032 revA July 2018

© Flex

#### MFR\_SET\_ROM\_MODE (0xD9)

Transfer Type: Write Block (4 bytes)

Description: Sends system into ROM mode. Issue this command before attempting to download new firmware to the controller.

Bit	Description	Format
31:0	Sends system into ROM mode. Issue this command before attempting to download new firmware to the controller.	ASCII

#### MFR\_ISHARE\_THRESHOLD (0xDA)

Transfer Type: R/W Block (8 bytes)

Description: Mfr. current sharing threshold level

Bit	Function	Description	Format
47:0	Mfr. current sharing threshold	Mfr. current sharing threshold level	Byte Array

Bit	Function	Description	Value	Function	Description
56	Enable/Disable	Enable or disable Active Current share	0	Disable	Disables active current share
			1	Enable	Enables active current share

#### MFR\_GET\_RAMP\_DATA (0xDB)

Transfer Type: Read Block (32 bytes)

Description: The command MFR\_GET\_RAMP\_DATA 0xDB retrieves 32 bytes of ramp data. 15 pairs of instant values of Vin and Vout are recorded during ramp and the interval is adjusted to the ramp time. The record counter value is recorded just before ramp. The record value is equal to last value of "snap shot cycles" + 1. This way it can be judged whether the ramp data was recorded before or after snap shot data. Only the first ramp in a power cycle will be recorded. Data is reset after a successful ramp up.

Bit	Function	Description	Format	Unit
255:248	Vout 14		Integer Unsigned	V
247:240	Vin 14		Integer Unsigned	V
239:232	Vout 13		Integer Unsigned	V
231:224	Vin 13		Integer Unsigned	V
223:216	Vout 12		Integer Unsigned	V
215:208	Vin 12		Integer Unsigned	V
207:200	Vout 11		Integer Unsigned	V
199:192	Vin 11		Integer Unsigned	V
191:184	Vout 10		Integer Unsigned	V
183:176	Vin 10		Integer Unsigned	V
175:168	Vout 9		Integer Unsigned	V
167:160	Vin 9		Integer Unsigned	V
159:152	Vout 8		Integer Unsigned	V
151:144	Vin 8		Integer Unsigned	V
143:136	Vout 7		Integer Unsigned	V
135:128	Vin 7		Integer Unsigned	V

**BMR458 series** Fully regulated DC/DC Converters  
Input 36-75 V, Output up to 50 A / 600 W

1/28701-BMR458 0032 revA July 2018

© Flex

Bit	Function	Description	Format	Unit
127:1 20	Vout 6		Integer Unsigned	V
119:1 12	Vin 6		Integer Unsigned	V
111:1 04	Vout 5		Integer Unsigned	V
103:9 6	Vin 5		Integer Unsigned	V
95:88	Vout 4		Integer Unsigned	V
87:80	Vin 4		Integer Unsigned	V
79:72	Vout 3		Integer Unsigned	V
71:64	Vin 3		Integer Unsigned	V
63:56	Vout 2		Integer Unsigned	V
55:48	Vin 2		Integer Unsigned	V
47:40	Vout 1		Integer Unsigned	V
39:32	Vin 1		Integer Unsigned	V
31:24	Vout 0		Integer Unsigned	V
23:16	Vin 0		Integer Unsigned	V
15:0	Counter		Integer Unsigned	Times

#### MFR\_SELECT\_TEMPERATURE\_SENSOR (0xDC)

Transfer Type: R/W Byte

Description: Select which temperature sensor, internal one or external remote temperature sensor, is used.

Bit	Description	Value	Function	Description
0	Select which temperature sensor, internal one or external remote temperature sensor, is used.	0	Internal IC Sensor	Internal IC temperature sensor selected.
		1	External Sensor	External remote temperature sensor selected.

#### MFR\_VIN\_OFFSET (0xDD)

Transfer Type: Read Block (4 bytes)

Description: Vin offset at ON and OFF.

Bit	Function	Description	Format
31:16	Mfr. Vin Offset on	Trimmed offset at ON	Byte Array
15:0	Mfr. Vin Offset off	Trimmed offset at OFF	Byte Array

#### MFR\_VOUT\_OFFSET\_MONITOR (0xDE)

Transfer Type: Read Word

Description: Output voltage trim

Bit	Description	Format	Unit
15:0	Output voltage trim	Vout Mode Signed	V

**BMR458 series Fully regulated DC/DC Converters**  
 Input 36-75 V, Output up to 50 A / 600 W

1/28701-BMR458 0032 revA

July 2018

© Flex

**MFR\_GET\_STATUS\_DATA (0xDF)**

Transfer Type: Read Block (32 bytes)

Description: The command MFR\_GET\_STATUS\_DATA 0xDF retrieves 32 bytes consisting of status words. The recording starts just after ramp has finished and continues during the first 128s after start up (16status word, 8s interval).

Bit	Function	Description	Format
255:2 40	Status Word 15	Status word 15.	Byte Array
239:2 24	Status Word 14	Status word 14.	Byte Array
223:2 08	Status Word 13	Status word 13.	Byte Array
207:1 92	Status Word 12	Status word 12.	Byte Array
191:1 76	Status Word 11	Status word 11.	Byte Array
175:1 60	Status Word 10	Status word 10.	Byte Array
159:1 44	Status Word 9	Status word 9.	Byte Array
143:1 28	Status Word 8	Status word 8.	Byte Array
127:1 12	Status Word 7	Status word 7.	Byte Array
111:9 6	Status Word 6	Status word 6.	Byte Array
95:80	Status Word 5	Status word 5.	Byte Array
79:64	Status Word 4	Status word 4.	Byte Array
63:48	Status Word 3	Status word 3.	Byte Array
47:32	Status Word 2	Status word 2.	Byte Array
31:16	Status Word 1	Status word 1.	Byte Array
15:0	Status Word 0	Status word 0.	Byte Array

**MFR\_SPECIAL\_OPTIONS (0xE0)**

Transfer Type: R/W Byte

Description: Special option configuration. Bit 0 - Reserved Bit 1 - Reserved Bit 2 - DBV: 0:Disabled 1:Enabled Bit 3 - ART/DLC: 0:Disabled 1:Enabled Bit 5 - DLS: 0:Linear droop 1:Non-linear droop Bit 7 - Require PEC

Bit	Function	Description	Value	Function	Description
7	Require Packet Error Check	Enables/Disables Packet Error Check.	0		Disabled
			1		Enabled
5	DLS slope configuration	Setup how the slope of the Vout droop is configured, with linear or non-linear droop.	0	Linear droop	Configured with linear droop
			1	Non-linear droop	Configured with non-linear droop
3	Enable ART/DLC, (Adaptive Ramp-up Time, Dynamic Loop Compensation)	Enables/Disables ART/DLC.	0		Disabled
			1		Enabled
2	Enable DBV, (Dynamic Bus Voltage)	Enables/Disables DBV.	0		Disabled
			1		Enabled

**MFR\_TEMP\_OFFSET\_INT (0xE1)**

Transfer Type: Read Word

Description: Internal temperature offset.

Bit	Description	Format	Unit
15:0	Integer [0.1 °C]	Direct	°C

**BMR458 series Fully regulated DC/DC Converters**  
 Input 36-75 V, Output up to 50 A / 600 W

1/28701-BMR458 0032 revA July 2018

© Flex

**MFR\_REMOTE\_TEMP\_CAL (0xE2)**

Transfer Type: Read Block (4 bytes)

Description: External temperature offset and slope.

Bit	Description	Format
31:0	$T(C) = \text{slope} \times \text{ADC}(v) + \text{offset}$ , Byte 0 byte 1: offset, Byte 2 byte 3: slope.	Byte Array

**MFR\_REMOTE\_CTRL (0xE3)**

Transfer Type: R/W Byte

Description: Primary Remote Control (RC pin) configuration.

Bit	Function	Description	Value	Function	Description
4	CTRL pin Interaction		0	OR'ed w/ CTRL pin	PriRC is OR:ed with OPERATION and CTRL pin.
			1	AND'ed w/ CTRL pin	PriRC is AND:ed with OPERATION and CTRL pin.
2	Remote CTRL pin Enabled	PriRC Pin Enable: 0:Disabled 1:Enabled	0	Disabled	
			1	Enabled	
1	Remote CTRL pin Polarity	PriRC Polarity: 0:Active Low 1:Active High	0	Active Low	
			1	Active High	
0	Remote Ctrl On/Off	Primary Remote Control (RC Pin) configuration. Bit 0 - PriRC Disable Mode: 0:Soft-Stop 1:Quick Off	0	Soft Stop	Pre-configured ramp down time set TOFF_FALL.
			1	Quick Off	Disables the output immediately.

**MFR\_VFF\_PARAMS (0xE6)**

Transfer Type: R/W Block (4 bytes)

Description: TBD.

Bit	Function	Description	Format
31:24	Setting 1		Integer Unsigned
23:16	High gain threshold		Integer Unsigned
15:8	High gain		Integer Unsigned
7:0	Referende adjust threshold		Integer Unsigned

**MFR\_TEMP\_COEFF (0xE7)**

Transfer Type: Read Block (6 bytes)

Description: Temperature coefficient

Bit	Function	Description	Format	Unit
47:40	Mfr. Temp level 2 Comp Factor	The temperature compensation factor for current sense above temperature level 2, used to compensate IOUT_READ value.	Integer Unsigned	
39:32	Mfr. Temp level 2 Comp	The second temperature level used to compensate IOUT_READ.	Integer Unsigned	°C
31:24	Mfr. Temp level 1 Comp Factor	The temperature compensation factor for current sense above temperature level 1, used to compensate IOUT_READ value.	Integer Unsigned	
23:16	Mfr. Temp level 1 Comp	The first temperature level used to compensate IOUT_READ.	Integer Unsigned	°C
15:0	Mfr. Temp Coeff Cu	The temperature coefficient for copper.	Direct	

**MFR\_FILTER\_COEFF (0xE8)**

Transfer Type: R/W Block (27 bytes)

Description: Mfr. filter coefficients

**BMR458 series** Fully regulated DC/DC Converters  
Input 36-75 V, Output up to 50 A / 600 W

1/28701-BMR458 0032 revA July 2018  
© Flex

Bit	Function	Description	Format
215:2 11	CLA scale	Filter Misc Gain Coefficient: CLA SCALE	Integer Unsigned
210:2 08	yn scale	Filter Misc Gain Coefficient: YN SCALE	Integer Unsigned
207:1 92	kcomp	Filter Misc Gain Coefficient: KCOMP	Integer Unsigned
191:1 76	KD alpha [1]	Filter Coefficient: KD alpha [1]	Integer Unsigned
175:1 60	KD alpha [0]	Filter Coefficient: KD alpha [0]	Integer Unsigned
159:1 44	KD coef [2]	Filter Coefficient: KD coef [2]	Integer Unsigned
143:1 28	KD coef [1]	Filter Coefficient: KD coef [1]	Integer Unsigned
127:1 12	KD coef [0]	Filter Coefficient: KD coef [0]	Integer Unsigned
111:9 6	KI coef [3]	Filter Coefficient: KI coef [3]	Integer Unsigned
95:80	KI coef [2]	Filter Coefficient: KI coef [2]	Integer Unsigned
79:64	KI coef [1]	Filter Coefficient: KI coef [1]	Integer Unsigned
63:48	KI coef [0]	Filter Coefficient: KI coef [0]	Integer Unsigned
47:32	KP coef [2]	Filter Coefficient: KP coef [2]	Integer Unsigned
31:16	KP coef [1]	Filter Coefficient: KP coef [1]	Integer Unsigned
15:0	KP coef [0]	Filter Coefficient: KP coef [0]	Integer Unsigned

**MFR\_FILTER\_NLR\_GAIN (0xE9)**

Transfer Type: R/W Block (16 bytes)  
Description: Mfr. filter nlrains

Bit	Function	Description	Format
121:1 20	AFE Gain	AFE gain	Integer Unsigned
95:80	limit5	Filter Coefficient: LIMIT 5	Integer Unsigned
79:64	limit4	Filter Coefficient: LIMIT 4	Integer Unsigned
63:48	limit3	Filter Coefficient: LIMIT 3	Integer Unsigned
47:32	limit2	Filter Coefficient: LIMIT 2	Integer Unsigned
31:16	limit1	Filter Coefficient: LIMIT 1	Integer Unsigned
15:0	limit0	Filter Coefficient: LIMIT 0	Integer Unsigned

Bit	Function	Description	Value	Function	Description
127:1 25	Bin Configuration (6)	Bin Configuration (6)	0	Coef [0]	
			1	Coef [1]	
			2	Coef [2]	
			3	Coef [3]	
			4	Coef [4]	
			5	Coef [5]	
			6	Coef [6]	
124	Bin Alpha (6)	Bin Alpha (6)			
123	NL Mode	NL Mode			
122	Auto Gear Shift	Auto Gear Shift			
119:1 17	Bin Configuration (4)	Bin Configuration (4)	0	Coef [0]	
			1	Coef [1]	
			2	Coef [2]	
			3	Coef [3]	
			4	Coef [4]	
			5	Coef [5]	
			6	Coef [6]	
116	Bin Alpha (4)	Bin Alpha (4)			
115:1 13		Bin Configuration (5)	0	Coef [0]	
			1	Coef [1]	

**BMR458 series** Fully regulated DC/DC Converters  
Input 36-75 V, Output up to 50 A / 600 W

1/28701-BMR458 0032 revA July 2018  
© Flex

Bit	Function	Description	Value	Function	Description
	Bin Configuration (5)		2	Coef [2]	
			3	Coef [3]	
			4	Coef [4]	
			5	Coef [5]	
			6	Coef [6]	
112	Bin Alpha (5)	Bin Alpha (5)			
111:109	Bin Configuration (2)	Bin Configuration (2)	0	Coef [0]	
			1	Coef [1]	
			2	Coef [2]	
			3	Coef [3]	
			4	Coef [4]	
			5	Coef [5]	
108	Bin Alpha (2)	Bin Alpha (2)			
107:105	Bin Configuration (3)	Bin Configuration (3)	0	Coef [0]	
			1	Coef [1]	
			2	Coef [2]	
			3	Coef [3]	
			4	Coef [4]	
			5	Coef [5]	
104	Bin Alpha (3)	Bin Alpha (3)			
103:101	Bin Configuration (0)	Bin Configuration (0)	0	Coef [0]	
			1	Coef [1]	
			2	Coef [2]	
			3	Coef [3]	
			4	Coef [4]	
			5	Coef [5]	
100	Bin Alpha (0)	Bin Alpha (0)			
99:97	Bin Configuration (1)	Bin Configuration (1)	0	Coef [0]	
			1	Coef [1]	
			2	Coef [2]	
			3	Coef [3]	
			4	Coef [4]	
			5	Coef [5]	
96	Bin Alpha (1)	Bin Alpha (1)			

**MFR\_MIN\_DUTY (0xEB)**

Transfer Type: R/W Word

Description: Set the minimum duty cycle and minimum deadtime at min duty.

Bit	Function	Description	Format	Unit
15:8	Mfr. Min duty		Integer Unsigned	ns
7:0	Mfr. Minimum deadtime		Integer Unsigned	ns

**MFR\_ACTIVE\_CLAMP (0xEC)**

Transfer Type: Read Word

Description: Active clamp

Bit	Function	Description	Format	Unit
14:8	Mfr. pulse delay	Set the delay of the pulse to the active clamp.	Integer Unsigned	x4 ns
7:0	Mfr. pulse width	Set the pulse width to the active clamp.	Integer Unsigned	x4 ns



**BMR458 series Fully regulated DC/DC Converters**  
 Input 36-75 V, Output up to 50 A / 600 W

1/28701-BMR458 0032 revA July 2018

© Flex

Bit	Function	Description	Value	Function	Description
15	Active Clamp mode	Set the mode of the active clamp, 1x frequency A and B output inverted outputs phase/2x frequency on A only non-inverted	0	1x frequency inverted	Set 1x frequency inverted
			1	2x frequency non-inverted	Set 2x frequency non-inverted

**MFR\_OFFSET\_ADDRESS (0xEE)**

Transfer Type: R/W Byte

Description: Value (n) add an offset to the address on SA0 pin when SA1 pin on the digital connector is used for synchronisation.

Bit	Description	Format	Unit
7:0		Integer Unsigned	n + SA0

**MFR\_DBV\_CONFIG (0xEF)**

Transfer Type: R/W Block (6 bytes)

Description: Configuration of Dynamic Bus Voltage.

Bit	Function	Description	Format	Unit
47:40	lout Level mid to high	lout level mid to high transition.	Fixed Point Signed	A
39:32	lout Level high to mid	lout level high to mid transition.	Fixed Point Signed	A
31:24	Output Voltage Mid	Output Voltage Mid.	Fixed Point Signed	V
23:16	lout Level low to mid	lout level low to mid transition.	Fixed Point Signed	A
15:8	lout Level mid to low	lout level mid to low transition.	Fixed Point Signed	A
7:0	Output Voltage Low	Output Voltage Low.	Fixed Point Signed	V

**MFR\_DEBUG\_BUFF (0xF0)**

Transfer Type: R/W Block (8 bytes)

Description: Output contents in debug\_buf.

Bit	Description	Format
63:0	Output contents in debug_buf.	Byte Array

**MFR\_SETUP\_PASSWORD (0xF1)**

Transfer Type: R/W Block (12 bytes)

Description: Once a valid new password is sent, the security is turned on.

Bit	Description	Format
95:0	A write is current password (6 bytes, default "000000000000") + new password (6 bytes) A read returns: 0x0000000000000000000000000000 if security is off 0x0000000000000000000000000001 if security is on 0x0000000000000000000000000002 if security setup is locked up due to incorrect password entry	ASCII

**MFR\_DISABLE\_SECURITY\_ONCE (0xF2)**

Transfer Type: R/W Block (6 bytes)

Description: When security is on, this command is used to temporarily disable the security before the next power reset of the digital PWM controller so that a host can send any command that is either write-protected or sendbyte-protected based on a security bit mask. When security is off, this command will be NACKed.

Bit	Description	Format
47:0	A write is current password (after it was set up with MFR_SETUP_PASSWORD).	ASCII

**BMR458 series Fully regulated DC/DC Converters**  
 Input 36-75 V, Output up to 50 A / 600 W

1/28701-BMR458 0032 revA July 2018

© Flex

**MFR\_SECURITY\_BIT\_MASK (0xF4)**

Transfer Type: Read Block (32 bytes)

Description: This command is used to individually enable or disable security feature for a write-protectable or sendbyte-protectable PMBUS command.

Bit	Description	Format
255:0	When protection is enabled for a PMBUS command and when security is on, the PMBUS command is write-protected or send- byte-protected.	Byte Array

**MFR\_TRANSFORMER\_TURN (0xF5)**

Transfer Type: Read Byte

Description: Transformer turn ratio.

Bit	Function	Description	Format
7:4	Mfr. Primary Turn	Number of turn on the primary side of transformer.	Integer Unsigned
3:0	Mfr. secondary Turn	Number of turn on the secondary side of transformer.	Integer Unsigned

**MFR\_OSC\_TRIM (0xF6)**

Transfer Type: Read Byte

Description: Internal clock frequency trim value

Bit	Description	Format
7:0	Internal clock frequency trim value.	Integer Unsigned

**MFR\_DLC\_CONFIG (0xF7)**

Transfer Type: R/W Block (8 bytes)

Description: Configuration of Dynamic Loop Compensation at start up.

Bit	Function	Description	Format	Unit
63:56	Ramp Factor 3, (K3)	Ramp factor for third limit. The value in Ramp Factor 3 is multiplied with the TON_RISE value, to calculate a new TON_RISE slope. The new calculated slope will immediately act as TON_RISE	Fixed Point Signed	
55:48	Third Limit	Third limit for adjustment. When the capacitance estimation reach over the third limit RAMP_FACTOR_3 is used and the PID setting in Bank 3 is chosen. To change PID settings in Bank 3, 0xD5 must be set to 0x03 after that 0xE8 and 0xE9 can be adjusted.	Fixed Point Signed	mF
47:40	Ramp Factor 2, (K2)	Ramp factor for second limit. The value in Ramp Factor 2 is multiplied with the TON_RISE value, to calculate a new TON_RISE slope. The new calculated slope will immediately act as TON_RISE	Fixed Point Signed	
39:32	Second Limit	Second limit for adjustment. When the capacitance estimation reach over the second limit RAMP_FACTOR_2 is used.	Fixed Point Signed	mF
31:24	Ramp Factor 1, (K1)	Ramp factor for first limit. The value in Ramp Factor 1 is multiplied with the TON_RISE value, to calculate a new TON_RISE slope. The new calculated slope will immediately act as TON_RISE	Fixed Point Signed	
23:16	First Limit	First limit for adjustment. When the capacitance estimation reach over the first limit RAMP_FACTOR_1 is used.	Fixed Point Signed	mF
15:8	Voltage End	Set the end level on the Vout ramp ON for the output cap estimation measurement.	Fixed Point Signed	V
7:0	Voltage Start	Set the start and end levels on the Vout ramp ON for the output cap estimation measurement.	Fixed Point Signed	V

**MFR\_ILIM\_SOFTSTART (0xF8)**

Transfer Type: R/W Byte

Description: During soft start ILIM is more than the user setting. The value set in this command is in % added ILIM.

Bit	Description	Format	Unit
7:0		Integer Unsigned	%

**BMR458 series** Fully regulated DC/DC Converters  
Input 36-75 V, Output up to 50 A / 600 W

1/28701-BMR458 0032 revA July 2018

© Flex

#### MFR\_MULTI\_PIN\_CONFIG (0xF9)

Transfer Type: R/W Byte

Description: The MFR\_MULTI\_PIN\_CONFIG command can be re-configured to enable or disable different functions and set the pin configuration of the digital header (K400) (pin 6-15).

Bit	Function	Description	Value	Function	Description
6:5	Sync Mode	These bits enables or disables the SYNC function. When enabling choose between SYNC OUT or SYNC IN.	00	Disabled	
			01	Sync in	When the product is configured to SYNC in it will synchronize its switching frequency to the product configured as SYNC out. The switching phases can be spread individually using the INTERLEAVE command 0x37
			10	Sync out	When the product is configured to SYNC out it will send out a SYNC signal that BMR458 products can connect its SYNC in pin. Only 1 product i a group can be configured to SYNC out.
3	SA1 as Sync	Change function of Pin 9 on the digital header (K400). This pin can be used as SA1 or SYNC in/out	0	SA1 normal	Pin 9 configured to set the PMBus address with a resistor connected to pin 9
			1	SA1 as Sync	Pin 9 configured to be used as SYNC input/output
2	Power Good Enable	This bit enable or disable the Power Good function	0	Disabled	
			1	Enabled	
1	Power Good Output	Two output options is available for Power Good output, it is Push/Pull or Open Drain	0	Push/Pull	Power Good configured Push/Pull
			1	Open Drain	Power Good configured Open Drain
0	CTRL Internal Resistor	Using CTRL internal resistor can be useful if no external pull up or pull down resistor exist or no Digital header (K400) is mounted.	0	Disabled	
			1	Enabled	

#### MFR\_ADDED\_DROOP\_DURING\_RAMP (0xFC)

Transfer Type: R/W Word

Description: Set an added droop during ramp.

Bit	Description	Format	Unit
15:0	Sets an added effective load line (V/I slope) for the rail in which the device is used, during ramp up.	Linear	mV/A

#### MFR\_FIRMWARE\_DATA (0xFD)

Transfer Type: Read Block (20 bytes)

Description: This is a 20-byte block that contains device ID and versions of the firmware.

Bit	Description	Format
159:0	This is a 20-byte block that contains device ID and versions of the firmware.	Byte Array

#### MFR\_RESTART (0xFE)

Transfer Type: Write Block (4 bytes)

Description: Writing the string "ERIC" to this command code forces the unit to restart.

Bit	Description	Format
31:0		ASCII