



Typical Applications

Prescaler for DC to X Band PLL Applications:

- Satellite Communication Systems
- Fiber Optic
- Point-to-Point and Point-to-Multi-Point Radios
- VSAT

Features

- Ultra Low SSB Phase Noise: -148 dBc/Hz
- Wide Bandwidth
- Output Power: 3 dBm
- Single DC Supply: +5V
- S8G SMT Package

Functional Diagram

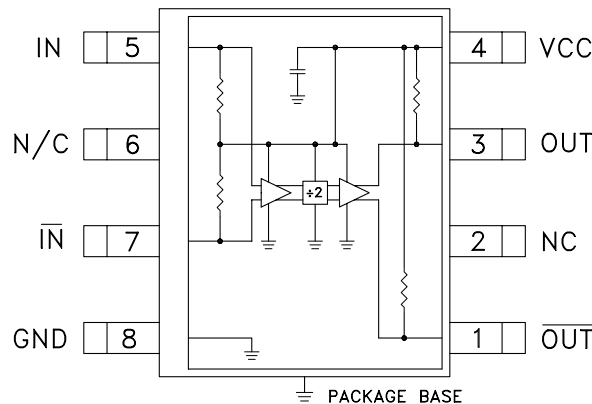

General Description

The HMC361S8G & HMC361S8GE are low noise Divide-by-2 Static Dividers with InGaP GaAs HBT technology in 8 lead surface mount plastic packages. This device operates from DC (with a square wave input) to 10 GHz input frequency with a single +5V DC supply. The low additive SSB phase noise of -148 dBc/Hz at 100 kHz offset helps the user maintain good system noise performance.

Electrical Specifications, $T_A = +25^\circ C$, 50 Ohm System, $V_{cc} = 5V$

| Parameter | Conditions | Min. | Typ. | Max. | Units |
|----------------------------------|---------------------------------------|------|------|------|--------|
| Maximum Input Frequency | | 10 | 11 | | GHz |
| Minimum Input Frequency | Sine Wave Input. ^[1] | | 0.2 | 0.5 | GHz |
| Input Power Range | $F_{in} = 1$ to 8 GHz | -15 | | +10 | dBm |
| | $F_{in} = 8$ to 10 GHz | -10 | | +2 | dBm |
| Output Power | $F_{in} = 6$ GHz | 0 | 3 | | dBm |
| | $F_{in} = 10$ GHz | -6 | | | dBm |
| Reverse Leakage | Both RF Outputs Terminated | | 45 | | dB |
| SSB Phase Noise (100 kHz offset) | $P_{in} = 0$ dBm, $F_{in} = 6$ GHz | | -148 | | dBc/Hz |
| Output Transition Time | $P_{in} = 0$ dBm, $F_{out} = 882$ MHz | | 100 | | ps |
| Supply Current (I_{cc}) | | | 83 | | mA |

1. Divider will operate down to DC for square-wave input signal.



**SMT GaAs HBT MMIC
DIVIDE-BY-2, DC - 10 GHz**

Input Sensitivity Window, $T = 25\text{ }^\circ\text{C}$

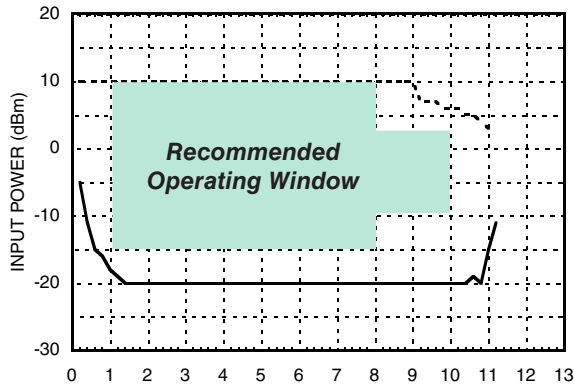

Input Sensitivity Window vs. Temperature

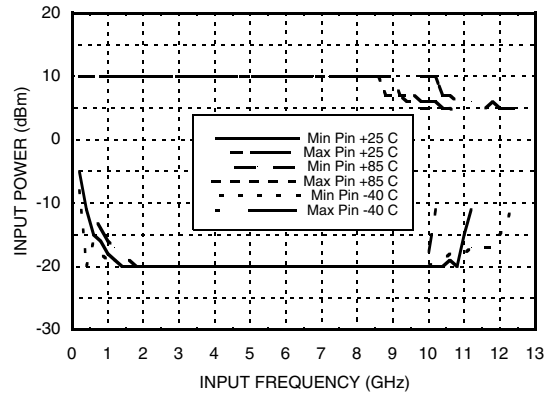

Output Power vs. Temperature

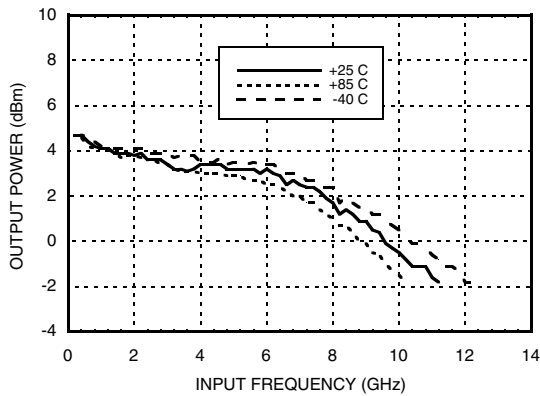

SSB Phase Noise

Performance, $P_{in} = 0\text{ dBm}$, $T = 25\text{ }^\circ\text{C}$

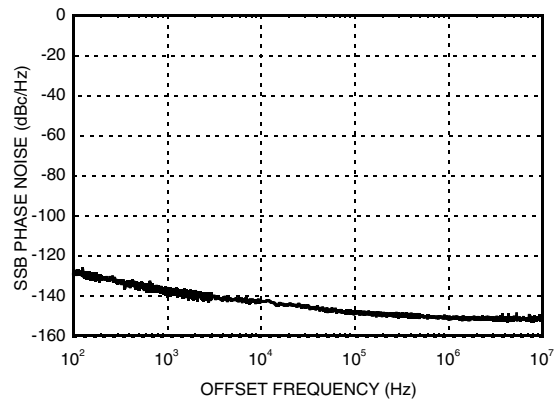

Output Harmonic

Content, $P_{in} = 0\text{ dBm}$, $T = 25\text{ }^\circ\text{C}$

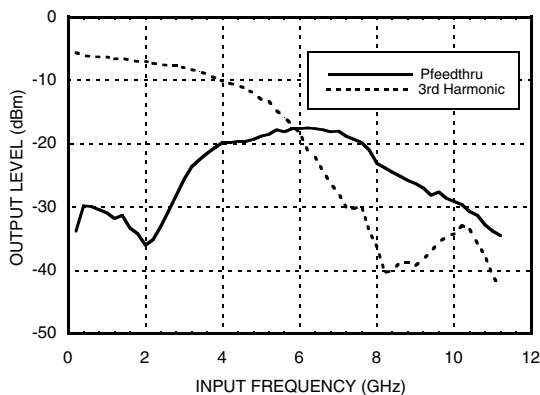

Reverse Leakage, $P_{in} = 0\text{ dBm}$, $T = 25\text{ }^\circ\text{C}$

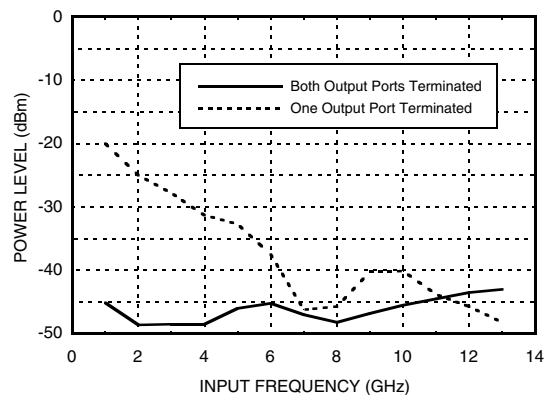



**SMT GaAs HBT MMIC
DIVIDE-BY-2, DC - 10 GHz**

**Output Voltage Waveform,
Pin = 0 dBm, Fout = 882 MHz, T = 25 °C**

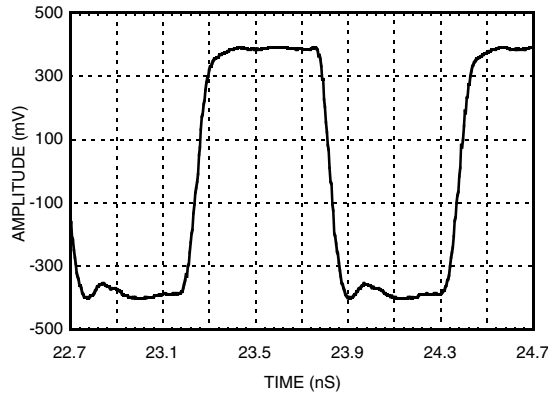

Absolute Maximum Ratings

| | |
|---|------------------------|
| RF Input (Vcc = +5V) | +13 dBm |
| Vcc | +5.5V |
| VLogic | Vcc -1.6V to Vcc -1.2V |
| Junction Temperature (Tj) | 135 °C |
| Continuous P _{diss} (T = 85 °C) (derate 15.9 mW/°C above 85 °C) | 0.79 W |
| Thermal Resistance (R _{TH}) (junction to ground paddle) | 63 °C/W |
| Storage Temperature | -65 to +150 °C |
| Operating Temperature | -40 to +85 °C |

Typical Supply Current vs. Vcc

| Vcc (V) | Icc (mA) |
|---------|----------|
| 4.75 | 74 |
| 5.0 | 83 |
| 5.25 | 89 |

Note: Divider will operate over full voltage range shown above

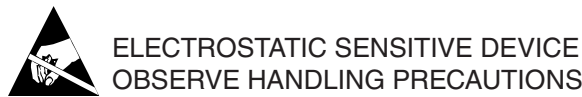

Outline Drawing

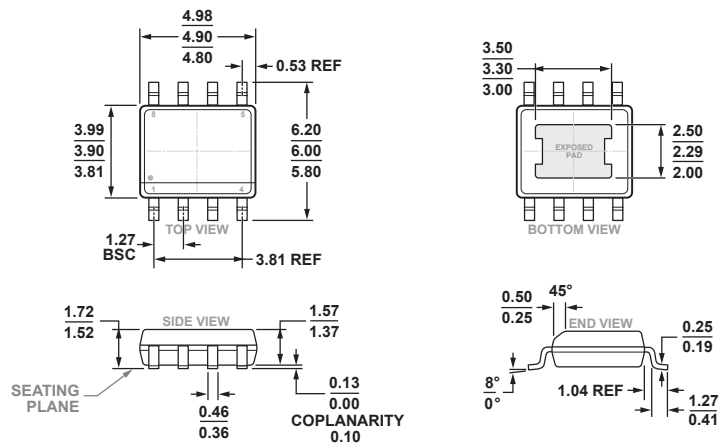

COMPLIANT TO JEDEC STANDARDS MS-012-BA

8-Lead Standard Small Outline Package, with Exposed Pad [SOIC_N_EP]
Narrow Body, Low Stand-off
(RD-8-3)
Dimensions shown in millimeters.

09-31-2021-A

09-31-2021-A



Package Information

| Part Number | Package Body Material | Lead Finish | MSL Rating | Package Marking ^[3] |
|----------------------|--|---------------|---------------------|--------------------------------|
| HMC361S8G | Low Stress Injection Molded Plastic | Sn/Pb Solder | MSL1 ^[1] | H361 XXXX |
| HMC361S8GE | RoHS-compliant Low Stress Injection Molded Plastic | 100% matte Sn | MSL1 ^[2] | H361 XXXX |
| HMC361S8GETR | RoHS-compliant Low Stress Injection Molded Plastic | 100% matte Sn | MSL1 ^[2] | H361 XXXX |
| HMC361S8GTR | Low Stress Injection Molded Plastic | Sn/Pb Solder | MSL1 ^[1] | H361 XXXX |
| 104631- HMC361S8G | Eval Board | | | |

[1] Max peak reflow temperature of 235 °C

[2] Max peak reflow temperature of 260 °C

[3] 4-Digit lot number XXXX

Pin Description

| Pin Number | Function | Description | Interface Schematic |
|------------|-------------------------|--|---------------------|
| 1 | $\overline{\text{OUT}}$ | Divided output 180° out of phase with pin 3. | |
| 2, 6 | N/C | No connection. These pins must not be grounded. | |
| 3 | OUT | Divided Output. | |
| 4 | VCC | Supply voltage 5V ± 0.25V. | |
| 5 | IN | RF Input must be DC blocked. | |
| 7 | $\overline{\text{IN}}$ | RF Input 180° out of phase with pin 5 for differential operation. A/C ground for single ended operation | |
| 8 | GND | Ground Backside of package has exposed metal ground slug which must be connected to ground. | |



Evaluation PCB

4

FREQUENCY DIVIDERS & DETECTORS - SMT

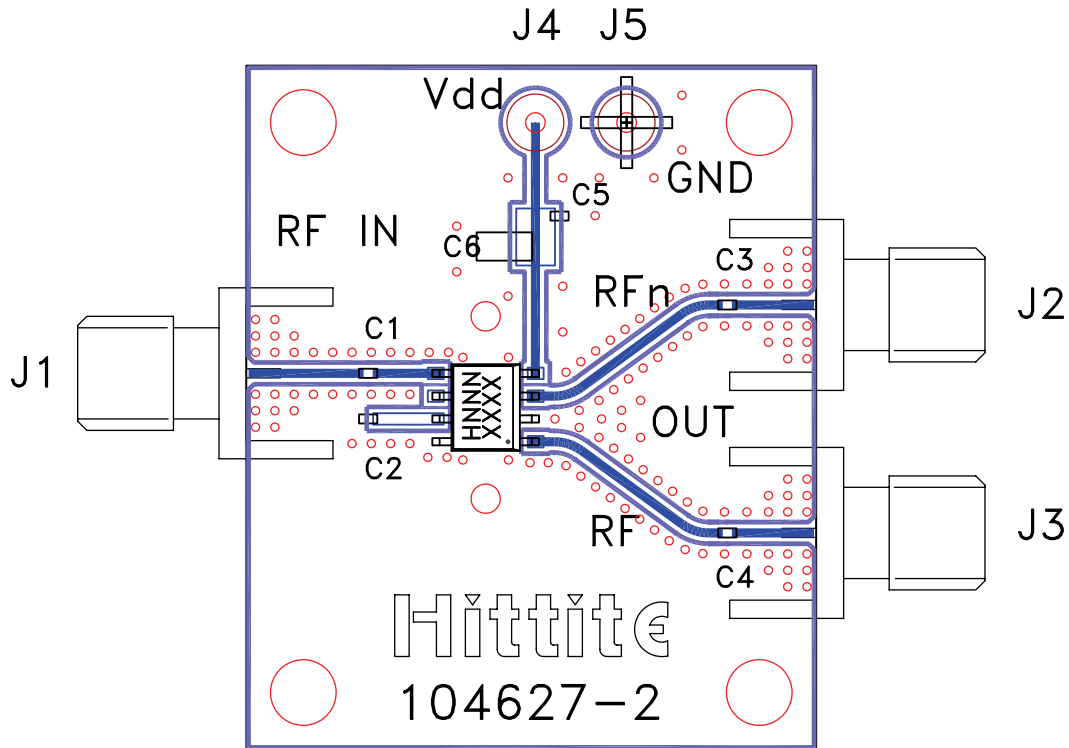

List of Materials for Evaluation PCB 104631 [1]

| Item | Description |
|---------|------------------------------------|
| J1 - J3 | PCB Mount SMA RF Connector |
| C1 - C4 | 100 pF Capacitor, 0402 Pkg. |
| C5 | 1000 pF Capacitor, 0603 Pkg. |
| C6 | 10 μ F Tantalum Capacitor |
| U1 | HMC361S8G / HMC361S8GE Divide-by-2 |
| PCB [2] | 104627 Eval Board |

[1] Reference this number when ordering complete evaluation PCB

[2] Circuit Board Material: Rogers 4350

The circuit board used in the application should use RF circuit design techniques. Signal lines should have 50 Ohm impedance while the package ground leads and backside ground slug should be connected directly to the ground plane similar to that shown. A sufficient number of via holes should be used to connect the top and bottom ground planes. The evaluation circuit board shown is available from Analog Devices upon request. This evaluation board is designed for single ended input testing. J2 and J3 provide differential output signals.



**SMT GaAs HBT MMIC
DIVIDE-BY-2, DC - 10 GHz**

Application Circuit

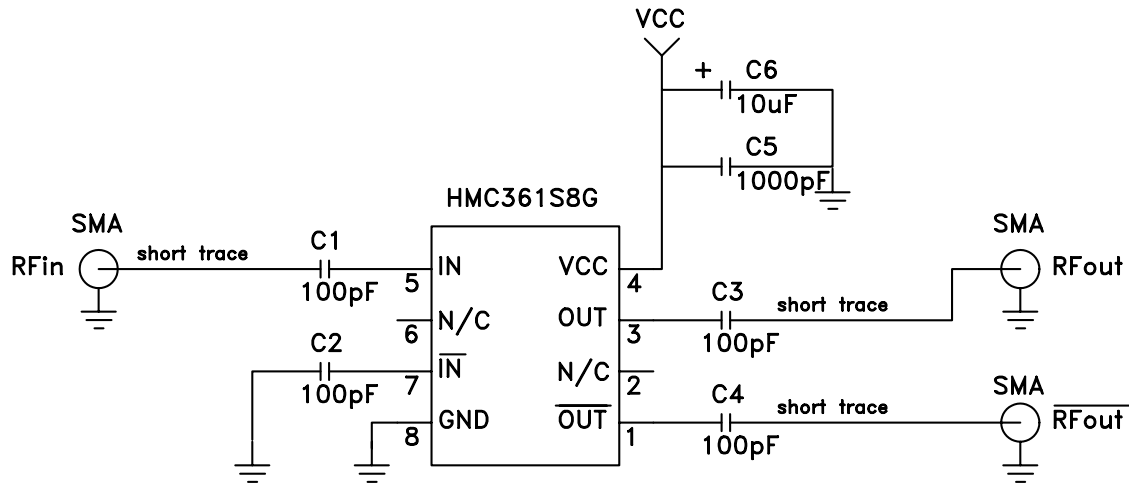

Mouser Electronics

Authorized Distributor

Click to View Pricing, Inventory, Delivery & Lifecycle Information:

[Analog Devices Inc.:](#)

[HMC361S8GE](#) [104631-HMC361S8G](#) [HMC361S8GETR](#) [HMC361S8G](#)