

## InGaP HBT GAIN BLOCK MMIC AMPLIFIER, DC - 4 GHz

### Typical Applications

An excellent cascadable 50 Ohm Gain Block or LO Driver for:

- Microwave & VSAT Radios
- Test Equipment
- Military EW, ECM, C<sup>3</sup>I
- Space Telecom

### Functional Diagram

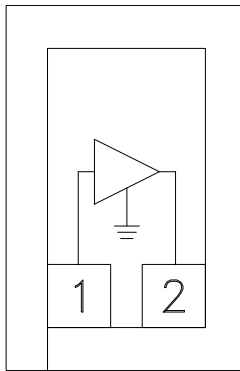

### Features

- Gain: 15 dB
- P1dB Output Power: +16 dBm
- Stable Gain Over Temperature
- 50 Ohm I/O's
- Small Size: 0.38 x 0.58 x 0.1 mm

### General Description

The HMC395 die is a GaAs InGaP Heterojunction Bipolar Transistor (HBT) Gain Block MMIC DC - 4 GHz amplifier. This amplifier die can be used as either a cascadable 50 Ohm gain stage or to drive the LO of HMC mixers with up to +17 dBm output power. The HMC395 offers 16 dB of gain and an output IP3 of +31 dBm while requiring only 54 mA from a +5V supply. The Darlington feedback pair used results in reduced sensitivity to normal process variations and yields excellent gain stability over temperature while requiring a minimal number of external bias components. The HMC395 can easily be integrated into Multi-Chip-Modules (MCMs) due to its small (0.22mm<sup>2</sup>) size. All data is with the chip in a 50 Ohm test fixture connected via 0.025mm (1mil) diameter wire bonds of minimal length 0.5mm (20mils).

### Electrical Specifications, Vs= +5.0V, Rbias= 22 Ohm, TA = +25° C

Parameter	Min.	Typ.	Max.	Units
Gain		DC - 1.0 GHz	16	dB
		1.0 - 4.0 GHz	15	dB
Gain Variation Over Temperature		DC - 1.0 GHz	0.004	dB/ °C
		1.0 - 4.0 GHz	0.008	dB/ °C
Input Return Loss		DC - 1.0 GHz	18	dB
		1.0 - 4.0 GHz	15	dB
Output Return Loss		DC - 1.0 GHz	17	dB
		1.0 - 4.0 GHz	10	dB
Reverse Isolation	DC - 4.0 GHz	19		dB
Output Power for 1 dB Compression (P1dB)		DC - 1.0 GHz	16	dBm
		1.0 - 2.0 GHz	15	dBm
		2.0 - 4.0 GHz	10	dBm
Output Third Order Intercept (IP3)		DC - 1.0 GHz	31	dBm
		1.0 - 2.0 GHz	28	dBm
		2.0 - 4.0 GHz	22	dBm
Noise Figure	DC - 4.0 GHz	4.5		dB
Supply Current (Icq)		54		mA

Note: Data taken with broadband bias tee on device output.

**InGaP HBT GAIN BLOCK  
MMIC AMPLIFIER, DC - 4 GHz**

**Gain & Return Loss**

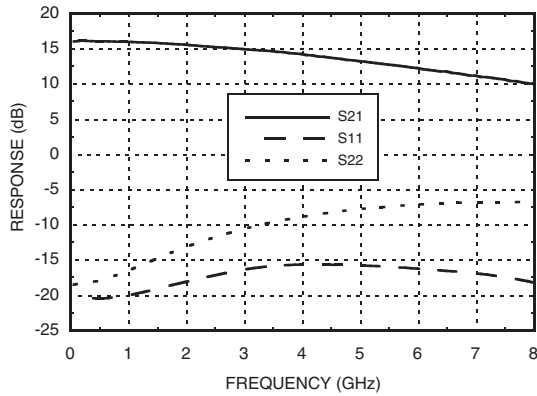

**Gain vs. Temperature**

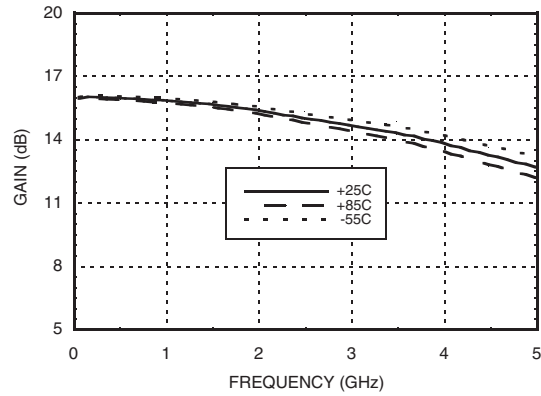

**Input Return Loss vs. Temperature**

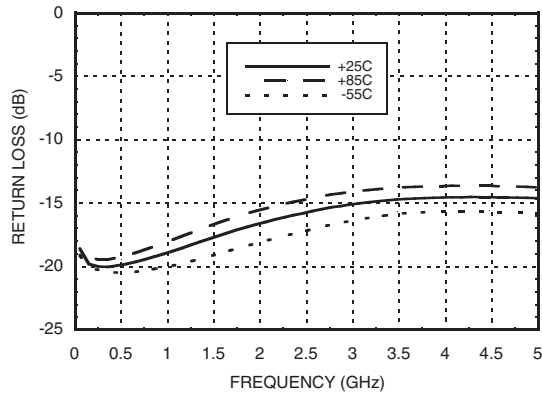

**Output Return Loss vs. Temperature**

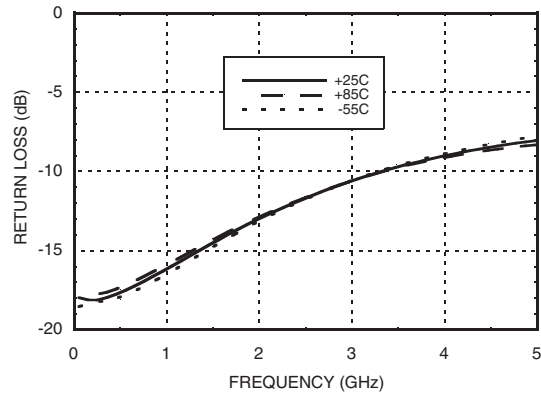

**Reverse Isolation vs. Temperature**

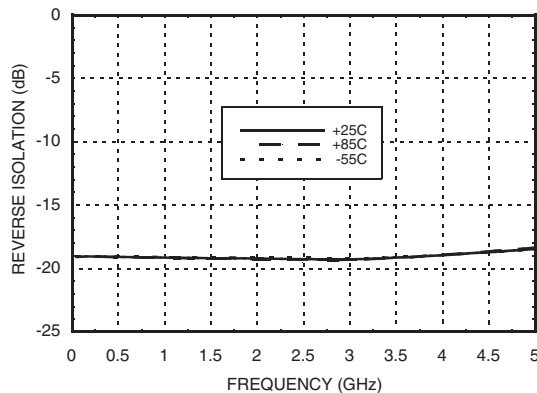

**Noise Figure vs. Temperature**

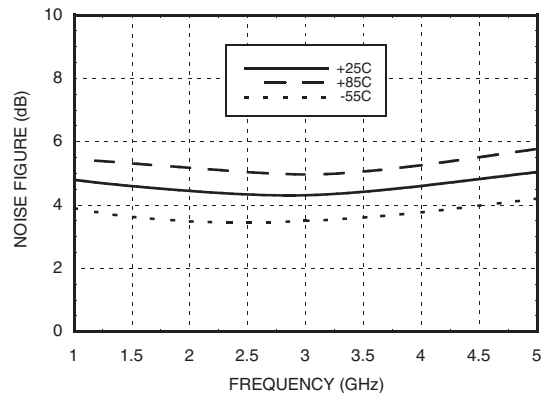

Information furnished by Analog Devices is believed to be accurate and reliable. However, no responsibility is assumed by Analog Devices for its use, nor for any infringements of patents or other rights of third parties that may result from its use. Specifications subject to change without notice. No license is granted by implication or otherwise under any patent or patent rights of Analog Devices. Trademarks and registered trademarks are the property of their respective owners.

For price, delivery, and to place orders: Analog Devices, Inc., One Technology Way, P.O. Box 9106, Norwood, MA 02062-9106 Phone: 781-329-4700 • Order online at [www.analog.com](http://www.analog.com) Application Support: Phone: 1-800-ANALOG-D

**InGaP HBT GAIN BLOCK  
MMIC AMPLIFIER, DC - 4 GHz**

**P1dB vs. Temperature**

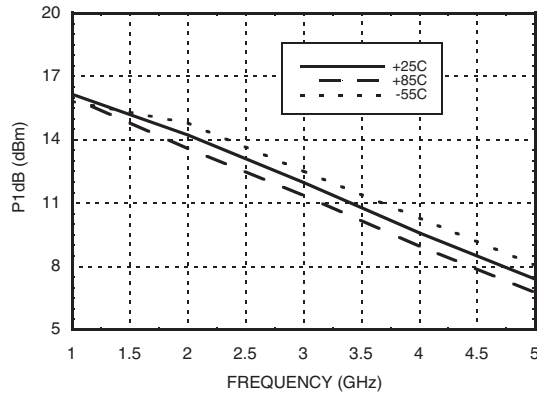

**Psat vs. Temperature**

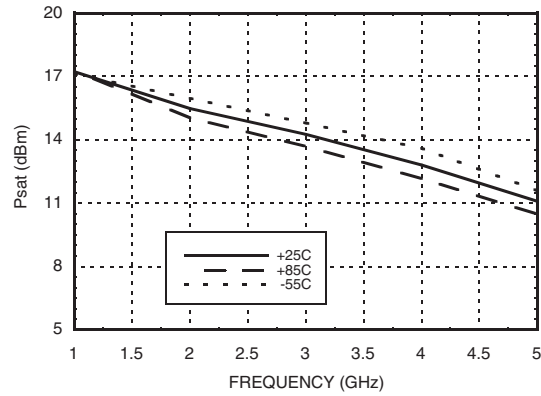

**Power Compression @ 1 GHz**

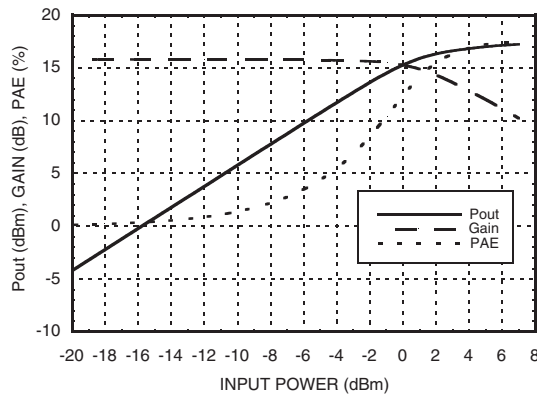

**Power Compression @ 4 GHz**

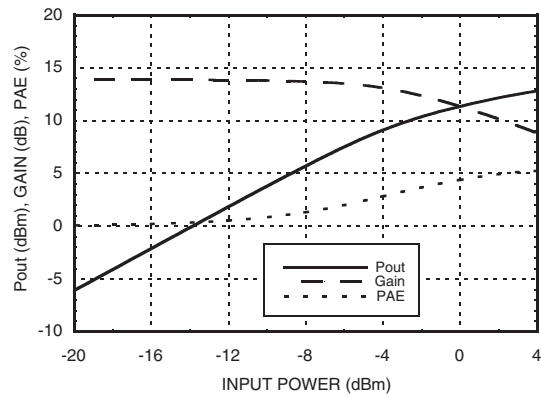

**Output IP3 vs. Temperature**

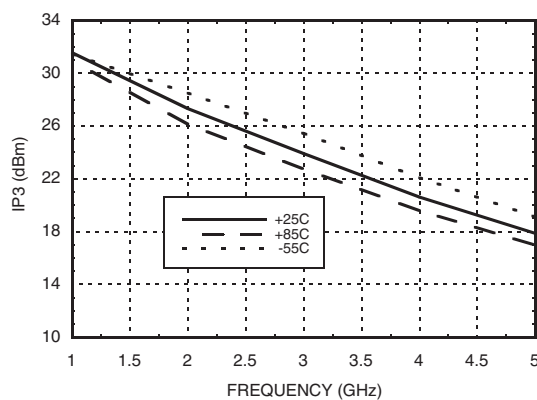

**Gain, Power, Output IP3 & Supply Current vs. Supply Voltage @ 1 GHz**

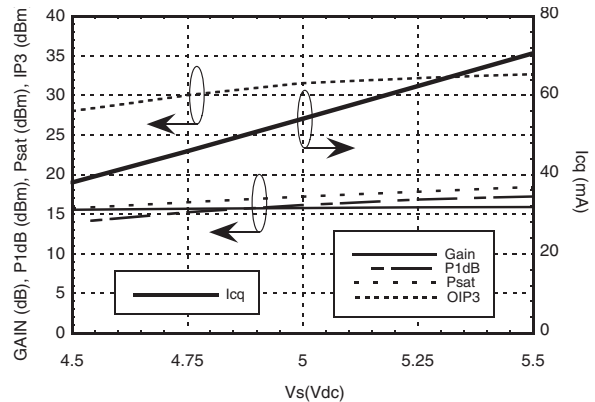

Information furnished by Analog Devices is believed to be accurate and reliable. However, no responsibility is assumed by Analog Devices for its use, nor for any infringements of patents or other rights of third parties that may result from its use. Specifications subject to change without notice. No license is granted by implication or otherwise under any patent or patent rights of Analog Devices. Trademarks and registered trademarks are the property of their respective owners.

For price, delivery, and to place orders: Analog Devices, Inc., One Technology Way, P.O. Box 9106, Norwood, MA 02062-9106 Phone: 781-329-4700 • Order online at [www.analog.com](http://www.analog.com) Application Support: Phone: 1-800-ANALOG-D

## InGaP HBT GAIN BLOCK MMIC AMPLIFIER, DC - 4 GHz

### Absolute Maximum Ratings

Collector Bias Voltage (Vcc)	+7.0 Vdc
RF Input Power (RFIN)(Vcc = +5.0 Vdc)	+10 dBm
Junction Temperature	150 °C
Continuous P <sub>diss</sub> (T = 85 °C) (derate 7.3 mW/°C above 85 °C)	0.475 W
Thermal Resistance (junction to die bottom)	137 °C/W
Storage Temperature	-65 to +150 °C
Operating Temperature	-55 to +85 °C



**ELECTROSTATIC SENSITIVE DEVICE  
OBSERVE HANDLING PRECAUTIONS**

### Outline Drawing

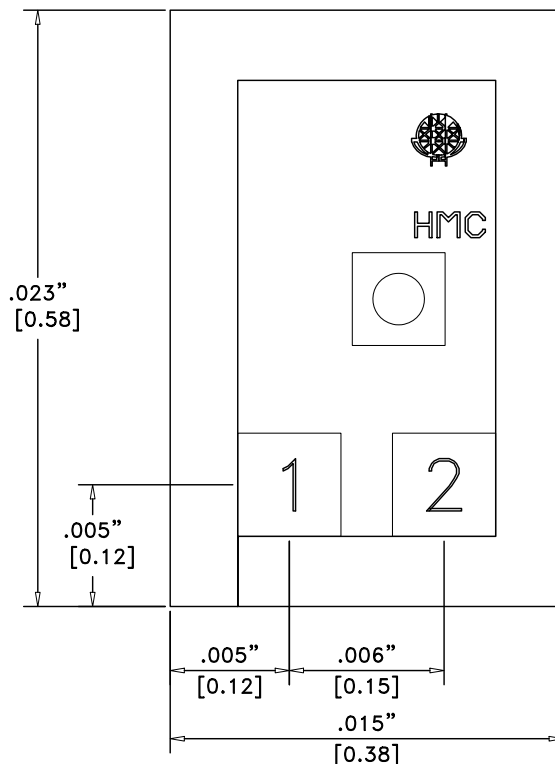

#### NOTES:

1. ALL DIMENSIONS IN INCHES [MILLIMETERS]
2. ALL TOLERANCES ARE ±0.001 (0.025)
3. DIE THICKNESS IS 0.004" (0.100) BACKSIDE IS GROUND
4. BOND PADS ARE 0.004" (0.100) SQUARE
5. BOND PAD SPACING, CTR-CTR: 0.006 (0.150)
6. BACKSIDE METALLIZATION: GOLD
7. BOND PAD METALLIZATION: GOLD

### Die Packaging Information <sup>[1]</sup>

Standard	Alternate
GP-3 (Gel Pack)	[2]

[1] Refer to the "Packaging Information" section for die packaging dimensions.

[2] For alternate packaging information contact Hittite Microwave Corporation.

## InGaP HBT GAIN BLOCK MMIC AMPLIFIER, DC - 4 GHz

### Pad Descriptions

Pad Number	Function	Description	Interface Schematic
1	RFIN	This pin is DC coupled. An off chip DC blocking capacitor is required.	
2	RFOUT	RF output and DC Bias for the output stage.	
Die Bottom	GND	Die bottom must be connected to RF/DC ground.	

### Application Circuit

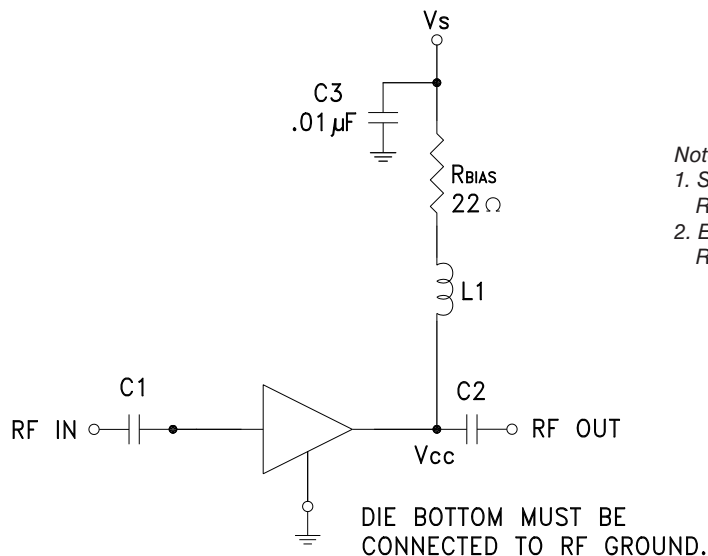

Note:

1. Select  $R_{bias}$  to achieve  $I_{cq}$  using equation below,  $R_{bias} \geq 22 \text{ Ohm}$ .
2. External blocking capacitors are required on RFIN and RFOUT.

$$I_{cq} = \frac{V_s - 3.9}{R_{bias}}$$

### Recommended Component Values

Component	Frequency (MHz)				
	50	100	500	1000	4000
L1	270 nH	270 nH	100 nH	56 nH	8.2 nH
C1, C2	0.01 $\mu$ F	0.01 $\mu$ F	500 pF	100 pF	100 pF

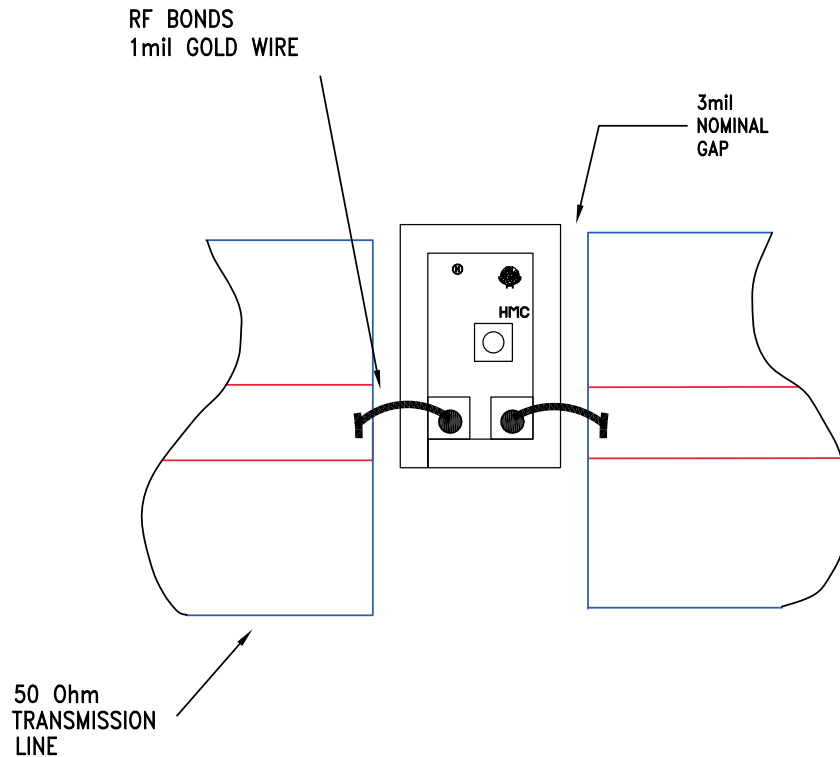
**InGaP HBT GAIN BLOCK  
MMIC AMPLIFIER, DC - 4 GHz**
**Assembly Diagram**

**Handling Precautions**

Follow these precautions to avoid permanent damage.

**Storage:** All bare die are placed in either Waffle or Gel based ESD protective containers, and then sealed in an ESD protective bag for shipment. Once the sealed ESD protective bag has been opened, all die should be stored in a dry nitrogen environment.

**Cleanliness:** Handle the chips in a clean environment. DO NOT attempt to clean the chip using liquid cleaning systems.

**Static Sensitivity:** Follow ESD precautions to protect against ESD strikes.

**Transients:** Suppress instrument and bias supply transients while bias is applied. Use shielded signal and bias cables to minimize inductive pick-up.

**General Handling:** Handle the chip along the edges with a vacuum collet or with a sharp pair of bent tweezers. The surface of the chip has fragile air bridges and should not be touched with vacuum collet, tweezers, or fingers.

**Mounting**

The chip is back-metallized and can be die mounted with AuSn eutectic preforms or with electrically conductive epoxy. The mounting surface should be clean and flat.

**Epoxy Die Attach:** Apply a minimum amount of epoxy to the mounting surface so that a thin epoxy fillet is observed around the perimeter of the chip once it is placed into position. Cure epoxy per the manufacturer's schedule.

**Wire Bonding**

Ball or wedge bond with 0.025mm (1 mil) diameter pure gold wire. Thermosonic wirebonding with a nominal stage temperature of 150 deg. C and a ball bonding force of 40 to 50 grams or wedge bonding force of 18 to 22 grams is recommended. Use the minimum level of ultrasonic energy to achieve reliable wirebonds. Wirebonds should be started on the chip and terminated on the package or substrate. All bonds should be as short as possible <0.31mm (12 mils).

# Mouser Electronics

Authorized Distributor

Click to View Pricing, Inventory, Delivery & Lifecycle Information:

[Analog Devices Inc.:](#)

[HMC395](#) [HMC395-SX](#)