



GaAs MMIC I/Q MIXER 3 - 7 GHz

Typical Applications

The HMC620LC4 is ideal for:

- Point-to-Point
- Point-to-Multi-Point Radio
- WiMAX & Fixed Wireless
- VSAT

Features

- Wide IF Bandwidth: DC - 3.5 GHz
- High Image Rejection: 32 dB
- High LO to RF Isolation: 43 dB
- High Input IP3: +22 dBm
- 24 Lead Ceramic 4x4 SMT Package: 16mm²

Functional Diagram

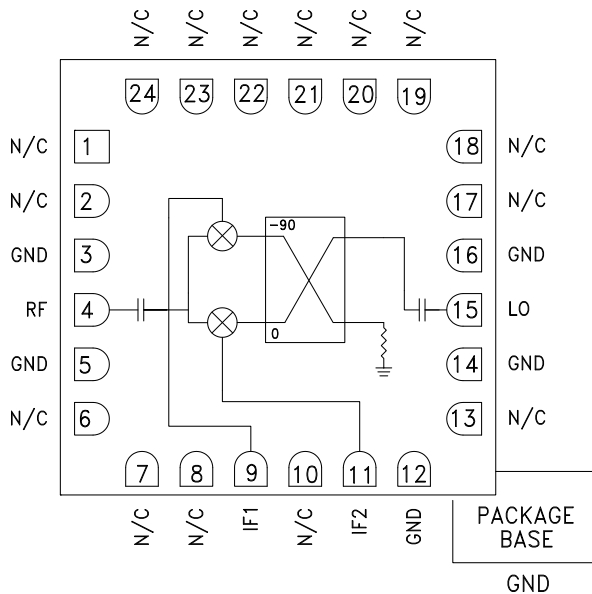

General Description

The HMC620LC4 is a compact I/Q MMIC mixer in a leadless “Pb free” RoHS compliant SMT package, which can be used as either an Image Reject Mixer (IRM) or a Single Sideband Upconverter. The mixer utilizes two standard Hittite double balanced mixer cells and a 90 degree hybrid fabricated in a GaAs MESFET process. A low frequency quadrature hybrid was used to produce a 100 MHz upper side band (USB) IF output. This product is a much smaller and more consistent alternative to hybrid style Image Reject Mixers and Single Sideband Upconverter assemblies. The HMC620LC4 is compatible with high volume surface mount manufacturing techniques.

Electrical Specifications, $T_A = +25\text{ }^\circ\text{C}$, $IF = 100\text{ MHz}$, $LO = +15\text{ dBm}$ *

| Parameter | Min. | Typ. | Max. | Min. | Typ. | Max. | Units |
|--------------------------|----------|------|------|----------|------|------|-------|
| Frequency Range, RF/LO | 3 - 7 | | | 3 - 4 | | | GHz |
| Frequency Range, IF | DC - 3.5 | | | DC - 3.5 | | | GHz |
| Conversion Loss (As IRM) | | 7.5 | 9 | | 8 | 9 | dB |
| Image Rejection | 20 | 27 | | 28 | 32 | | dB |
| 1 dB Compression (Input) | | 12 | | | 12 | | dBm |
| LO to RF Isolation | 38 | 43 | | 38 | 40 | | dB |
| LO to IF Isolation | 26 | 30 | | 32 | 33 | | dB |
| IP3 (Input) | | 22 | | | 17 | | dBm |
| Amplitude Balance | | 0.1 | | | 0.3 | | dB |
| Phase Balance | | 3 | | | 3 | | Deg |

* Unless otherwise noted, all measurements performed as downconverter.



**GaAs MMIC I/Q MIXER
3 - 7 GHz**

Data taken As IRM With External IF 90° Hybrid

Conversion Gain vs. Temperature

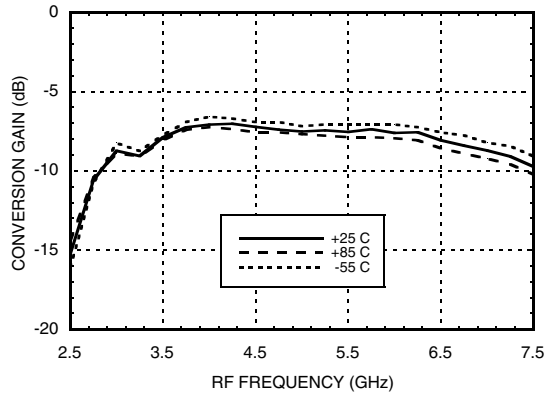
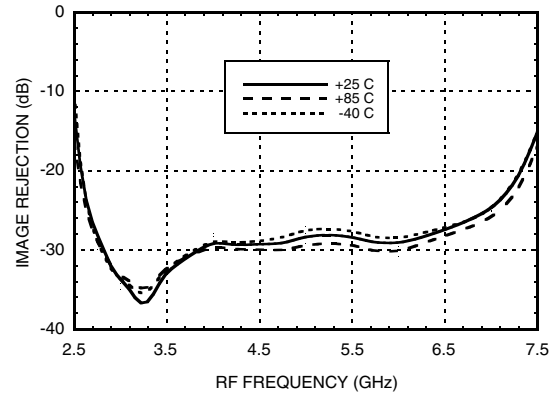
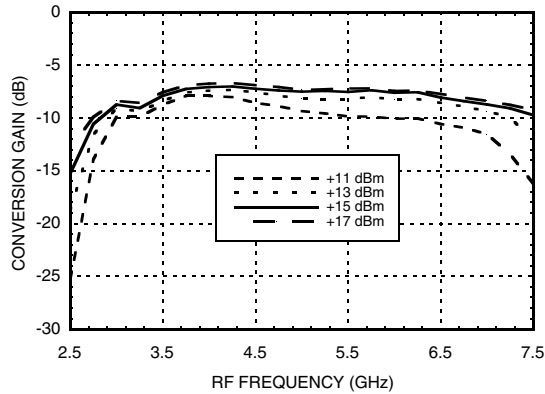

Image Rejection vs. Temperature



Conversion Gain vs. LO Drive



Return Loss

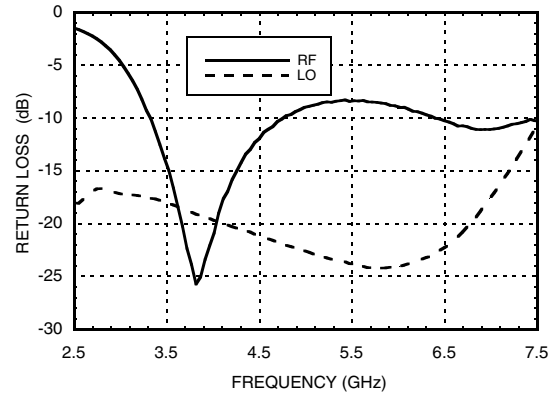

Input P1dB vs. Temperature

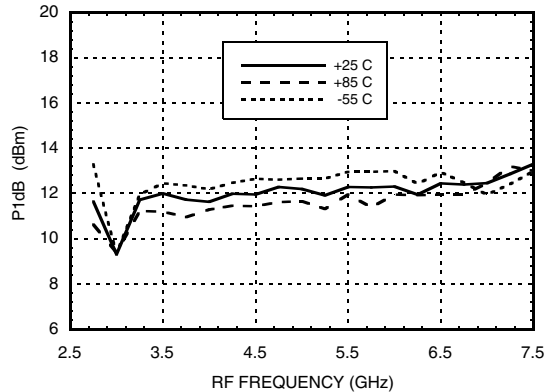

Input IP3 vs. LO Drive

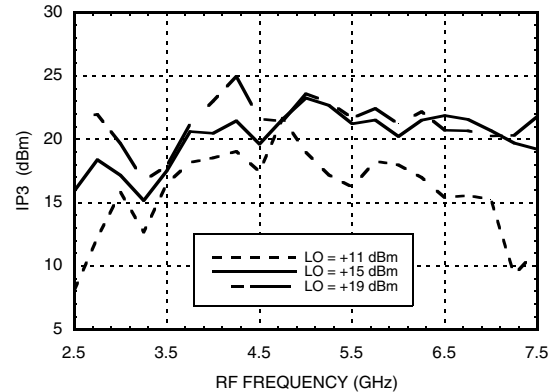

Information furnished by Analog Devices is believed to be accurate and reliable. However, no responsibility is assumed by Analog Devices for its use, nor for any infringements of patents or other rights of third parties that may result from its use. Specifications subject to change without notice. No license is granted by implication or otherwise under any patent or patent rights of Analog Devices. Trademarks and registered trademarks are the property of their respective owners.

For price, delivery, and to place orders: Analog Devices, Inc., One Technology Way, P.O. Box 9106, Norwood, MA 02062-9106 Phone: 781-329-4700 • Order online at www.analog.com Application Support: Phone: 1-800-ANALOG-D



**GaAs MMIC I/Q MIXER
3 - 7 GHz**

Isolations

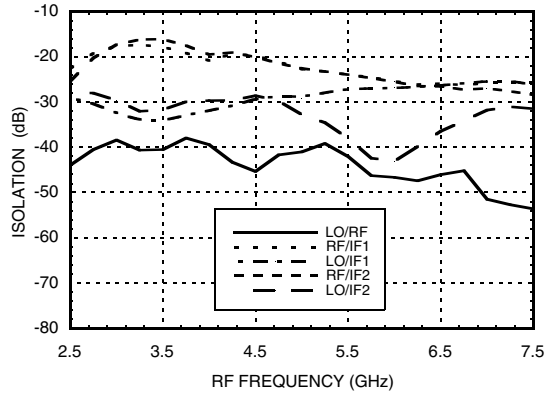

IF Bandwidth*

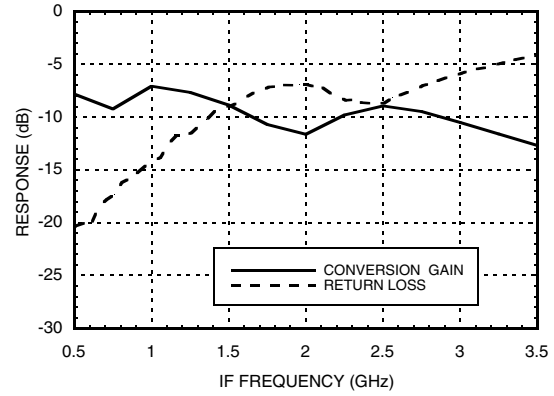

Amplitude Balance vs. LO Drive

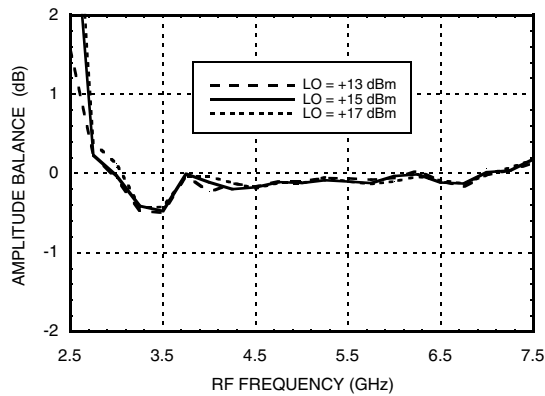

Phase Balance vs. LO Drive

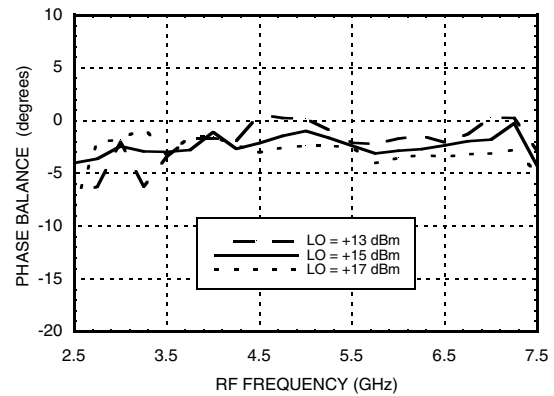

Upconverter Performance Conversion Gain vs. LO Drive

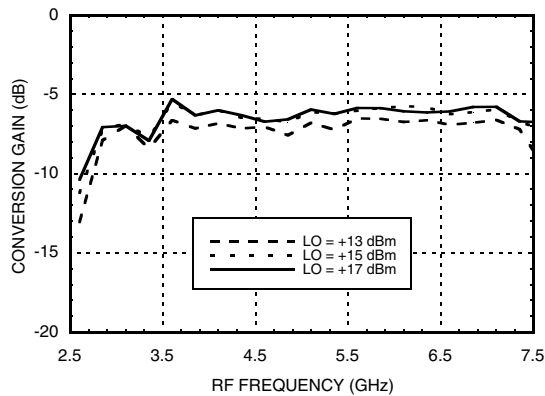

Upconverter Performance Sideband Rejection vs. LO Drive

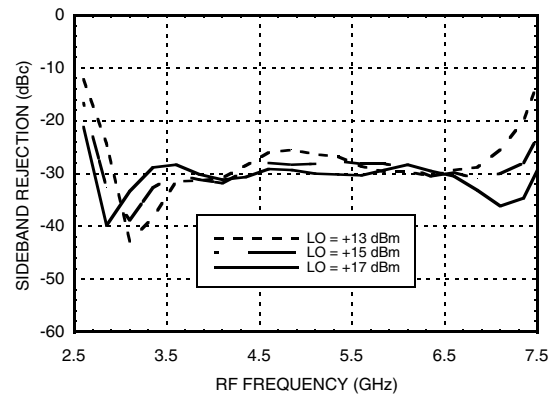

* Conversion gain data taken with external IF 90° hybrid

Information furnished by Analog Devices is believed to be accurate and reliable. However, no responsibility is assumed by Analog Devices for its use, nor for any infringements of patents or other rights of third parties that may result from its use. Specifications subject to change without notice. No license is granted by implication or otherwise under any patent or patent rights of Analog Devices. Trademarks and registered trademarks are the property of their respective owners.

For price, delivery, and to place orders: Analog Devices, Inc., One Technology Way, P.O. Box 9106, Norwood, MA 02062-9106 Phone: 781-329-4700 • Order online at www.analog.com Application Support: Phone: 1-800-ANALOG-D

**GaAs MMIC I/Q MIXER
3 - 7 GHz**
Harmonics of LO

| LO Freq. (GHz) | nLO Spur at RF Port | | | |
|----------------|---------------------|----|----|----|
| | 1 | 2 | 3 | 4 |
| 2.5 | 29 | 35 | 48 | 30 |
| 3 | 26 | 33 | 51 | 39 |
| 4 | 28 | 32 | 39 | 43 |
| 5 | 28 | 36 | 45 | 52 |
| 6 | 36 | 44 | 60 | 41 |
| 7 | 40 | 36 | 58 | 34 |
| 7 | 46 | 37 | 55 | 46 |

LO = +15 dBm
Values in dBc below input LO level measured at RF Port.

MxN Spurious Outputs

| mRF | nLO | | | | |
|-----|-----|----|----|----|----|
| | 0 | 1 | 2 | 3 | 4 |
| 0 | xx | 1 | 15 | 28 | 69 |
| 1 | 15 | 0 | 30 | 39 | 50 |
| 2 | 69 | 61 | 78 | 60 | 71 |
| 3 | 95 | 95 | 95 | 73 | 95 |
| 4 | 95 | 95 | 95 | 95 | 95 |

RF = 5.6 GHz @ -10 dBm
LO = 5.5 GHz @ +15 dBm
Data taken without IF 90° hybrid
All values in dBc with reference to output power at IF = 100 MHz

Absolute Maximum Ratings

| | |
|--|----------------|
| RF / IF Input | +20 dBm |
| LO Drive | +27 dBm |
| Channel Temperature | 150 °C |
| Continuous Pdiss (T=85°C) (derate 8.93 mW/°C above 85°C) | 579 mW |
| Thermal Resistance (R _{TH}) (channel to die bottom) | 112 °C/W |
| Storage Temperature | -65 to +150 °C |
| Operating Temperature | -55 to +85 °C |



**ELECTROSTATIC SENSITIVE DEVICE
OBSERVE HANDLING PRECAUTIONS**

Outline Drawing

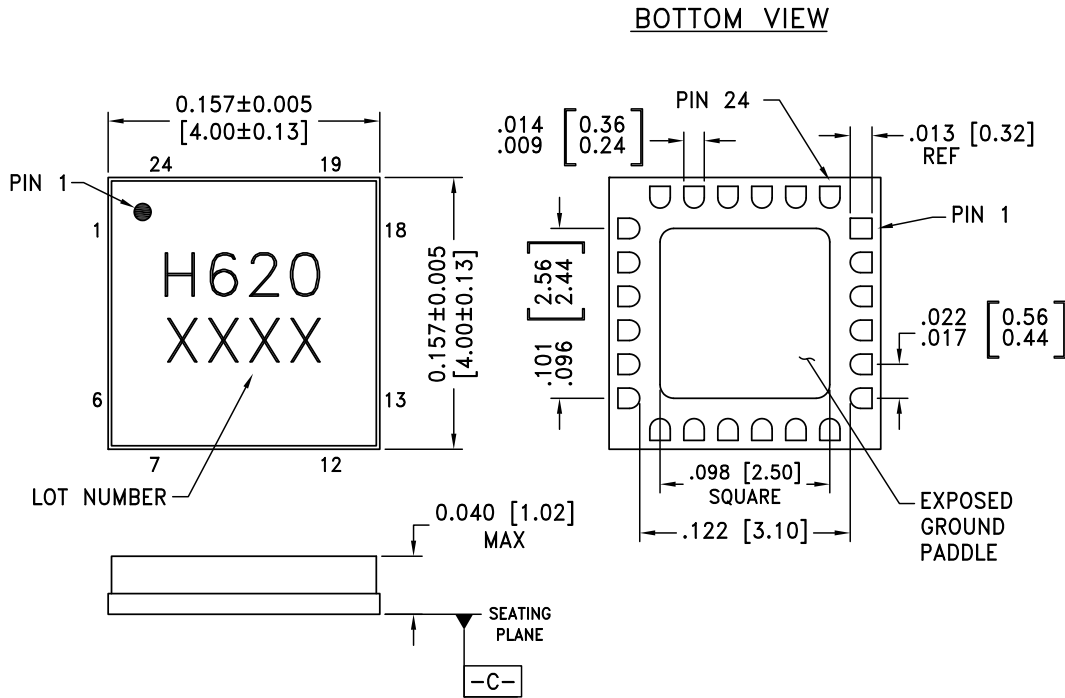

NOTES:

1. PACKAGE BODY MATERIAL: ALUMINA
2. LEAD AND GROUND PADDLE PLATING: 30 - 80 MICROINCHES GOLD OVER 50 MICROINCHES MINIMUM NICKLE
3. DIMENSIONS ARE IN INCHES [MILLIMETERS]
4. LEAD SPACING TOLERANCE IS NON-CUMULATIVE
5. PACKAGE WARP SHALL NOT EXCEED 0.05mm DATUM
6. ALL GROUND LEADS AND GROUND PADDLE MUST BE SOLDERED TO PCB RF GROUND

Package Information

| Part Number | Package Body Material | Lead Finish | MSL Rating | Package Marking ^[2] |
|-------------|-----------------------|------------------|---------------------|--------------------------------|
| HMC620LC4 | Alumina, White | Gold over Nickel | MSL3 ^[1] | H620 XXXX |

[1] Max peak reflow temperature of 260 °C

[2] 4-Digit lot number XXXX

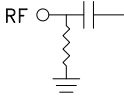
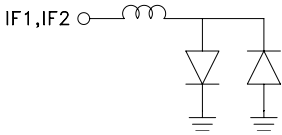
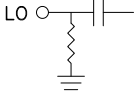

Pin Descriptions

| Pin Number | Function | Description | Interface Schematic |
|------------------------------------|----------|--|--|
| 1, 2, 6 - 8, 10, 13, 17 - 24 | N/C | No connection required. These pins may be connected to RF/DC ground without affecting performance. | |
| 3, 5, 12, 14, 16 | GND | These pins and package bottom must be connected to RF/DC ground. |  |
| 4 | RF | This pin is DC coupled and matched to 50 Ohms. |  |
| 9 | IF1 | This pin is DC coupled. For applications not requiring operation to DC, this port should be DC blocked externally using a series capacitor whose value has been chosen to pass the necessary IF frequency range. For operation to DC, this pin must not source/sink more than 3mA of current or part non-function and possible part failure will result. |  |
| 11 | IF2 | | |
| 15 | LO | This pin is DC coupled and matched to 50 Ohms. |  |



Evaluation PCB

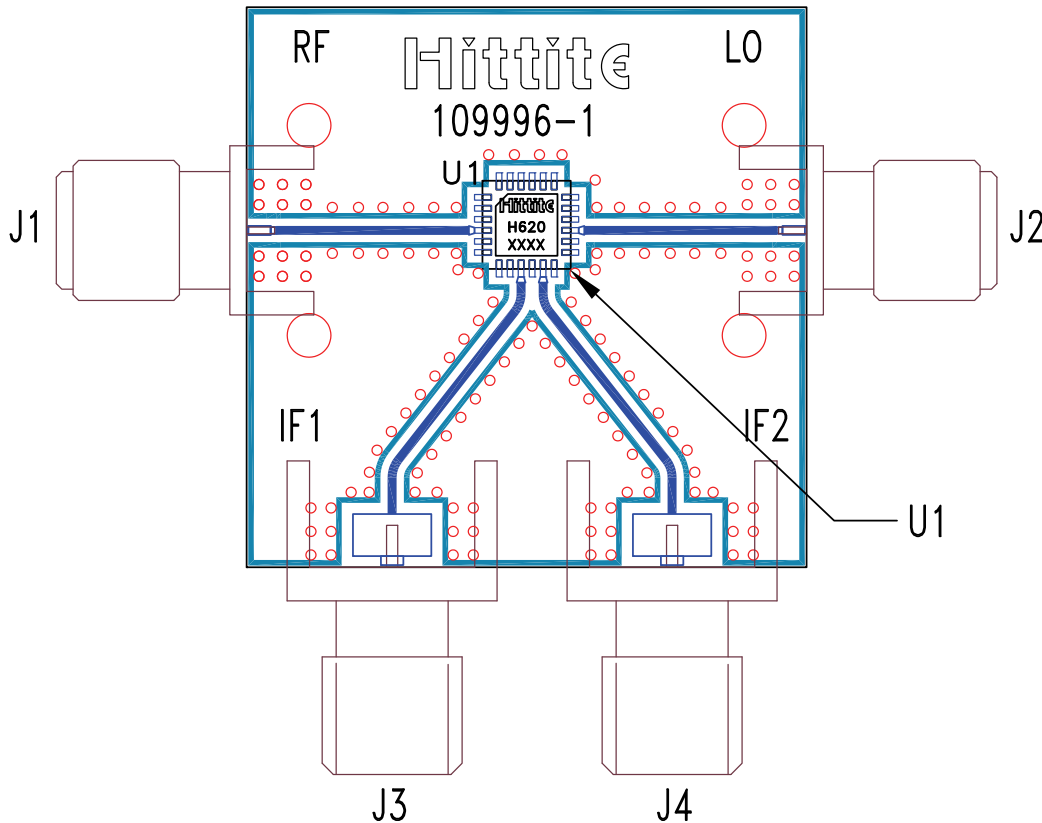

List of Materials for Evaluation PCB 109998 [1]

| Item | Description |
|---------|----------------------------------|
| J1, J2 | PCB Mount SMA RF Connector, SRI |
| J3 - J4 | PCB Mount SMA Connector, Johnson |
| U1 | HMC620LC4 |
| PCB [2] | 109996 Evaluation Board |

[1] Reference this number when ordering complete evaluation PCB

[2] Circuit Board Material: Rogers 4350

The circuit board used in the application should use RF circuit design techniques. Signal lines should have 50 Ohm impedance while the package ground leads and exposed paddle should be connected directly to the ground plane similar to that shown. A sufficient number of via holes should be used to connect the top and bottom ground planes. The evaluation circuit board shown is available from Hittite upon request.



Mouser Electronics

Authorized Distributor

Click to View Pricing, Inventory, Delivery & Lifecycle Information:

[Analog Devices Inc.:](#)

[HMC620LC4](#) [HMC620LC4TR](#)